

深圳上线科技有限公司	Doc.No.:	
	REV : A	PAGE : 1/16
SPEC TITLE DOCUMENT CONTROL SPECIFICATION	EFFECTIVE DATE : 2023-05-05	

Specifications

TFT-LCDmodule

Model No: SX395HVGA40P-01-V01

For Customer's Acceptance	
Approved by	Comment

	Signature	Date
Prepared by		
Checked by		
Approved by		

深圳上线科技有限公司	Doc.No.:	
	REV : A	PAGE : 2/16
SPEC TITLE DOCUMENT CONTROL SPECIFICATION	EFFECTIVE DATE : 2023-05-05	

Contents

1	General Description	3
1.1	Features	3
1.2	Application	3
2	Outline Dimension	3
3	Module specification of the module	4
4	Electrical Characteristics	5
4.1	TFT-LCD Module	5
4.2	Back-Light Unit	5
5	TFT-LCM Interface Specification	7
6	Timing Characteristics	8
7.	Optical Specification	8
8	Environment Absolute Maximum Ratings	11
9	Reliability Test Items	11
10	Inspaction Standard	12
11	Package	13
12	Precautions	14
12.1	Handling	14
12.2	Storage	14
12.3	Operation	15
12.4	Touch Panel Mounting Notes	15
12.5	Others	16
13	Records of Version	16

深圳上线科技有限公司	Doc.No.:	
	REV : A	PAGE : 3/16
SPEC TITLE DOCUMENT CONTROL SPECIFICATION	EFFECTIVE DATE : 2023-05-05	

1 General Description

SX395HVGA40P-01-V01 is a transmissive type a-Si TFT-LCD (amorphous silicon thin film transistor liquid crystal display) module, which is composed of a TFT-LCD panel, a driver circuit a backlight unit, The panel size is 3.95inch and thresolution is 320X480. High image quality a-Si TFT LCD module. Partial-screen display function is available. Sleep and Stand-by modes are available for power saving.

1.1 Features

No	Item	Specification	Remark
1	Display Mode	High Resolution & Wide View	
2	Screen Size	3.95inch (diagonal)	
3	Resolution	320XRGBX480	
4	Color Number	262K TFT	
5	Color Arrangement	RGB-stripe	
6	Driver IC	ILI9488	
7	Back Light	White LED*8	
8	Viewing Direction	12 O'clock	
9	Interface	MCU 8/MCU16 Bit/4-Line SPI	
10	Surface Treatment	UV Cut	
11	Module brightness	300 cd/m ²	

1.2 Application

- ◆ Mobile phone.
- ◆ Portable multimedia device.

2 Outline Dimension

The mechanical detail is shown in Fig. 1 and summarized in Table 1 below.

Parameter	Specifications	Unit
Outline dimensions	60.08(W) x94.57(H) x 2.5(D) (LCM,no include FPC)	mm
Active area	55.68(W) x83.52(H)	mm
Resolution	320(H)RGBx480(V)	dots
Dot size	0.174(H) x 0.174(V)	mm

3 Module specification of the module

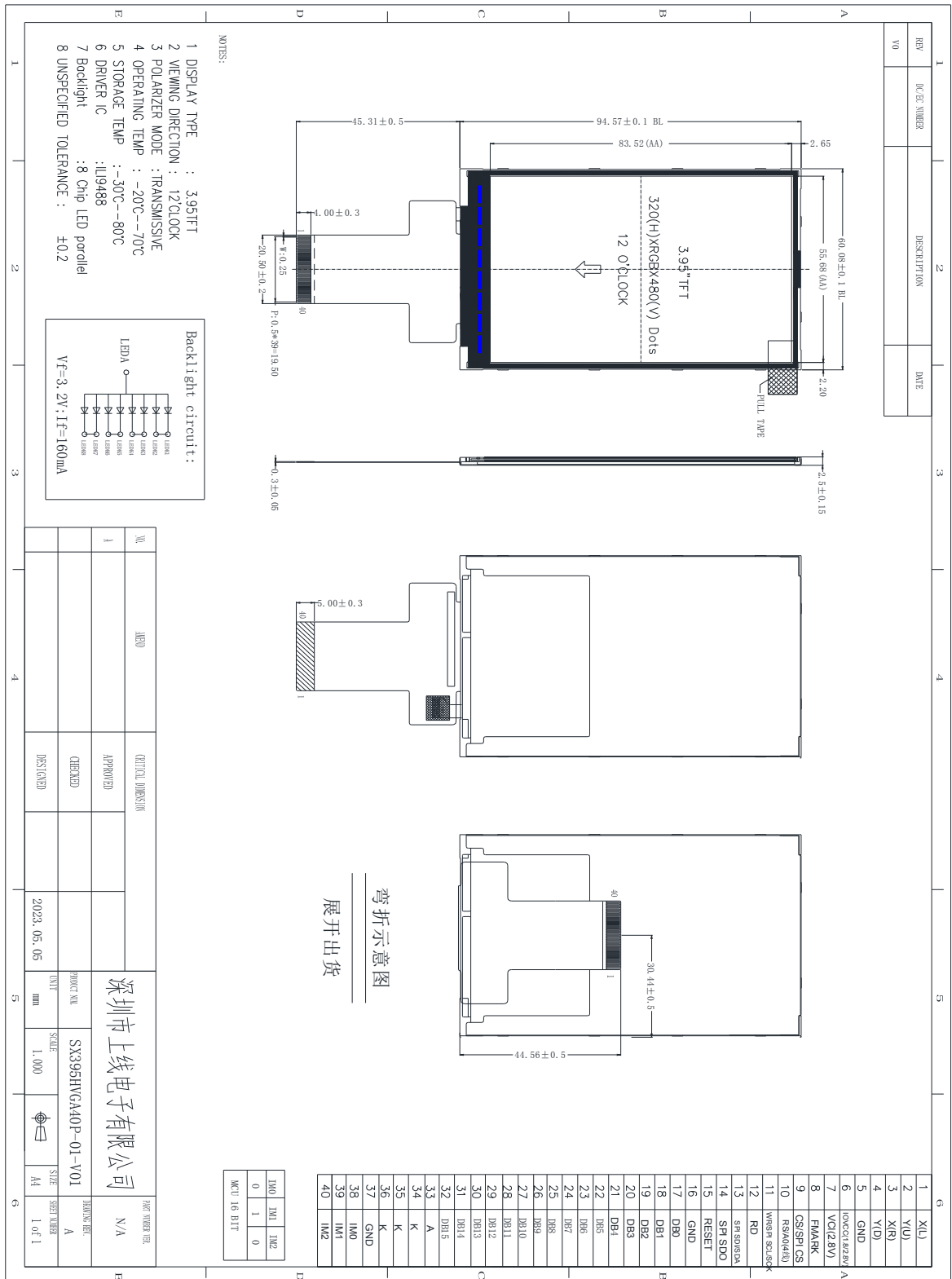

4 Electrical Characteristics

4.1 TFT-LCD Module

Item	Symbol	Condition	Min.	Typ.	Max.	Unit	Note
Power & Operation Voltage							
Analog operating voltage	VCI	-	2.5	2.8	3.3	V	
Logic operating voltage	IOVCC	-	1.65	1.8	3.3	V	Note 1, 2
OTP Supply voltage	DDVDH	-	-	7	-	V	Note 1
Logic High level input voltage	VIH	-	0.7*IOVCC		IOVCC	V	Note 1
Logic Low level input voltage	VIL	-	-0.3		0.3*IOVCC	V	Note 1
Logic High level output voltage TE, SDO (SDA) , CABC_PWM	VOH	IOH = -1.0mA	0.8*IOVCC		IOVCC	V	Note 1
Logic Low level output voltage TE, SDO (SDA) , CABC_PWM	VOL	IOL = +1.0mA	0		0.2*IOVCC	V	Note 1
Gate Driver High Voltage	VGH	-	10.0	-	20	V	
Gate Driver Low Voltage	VGL	-	-15.0	-	-6.0	V	
Driver Supply Voltage	-	VGH-VGL	16	-	32	V	
Input and Output							
Logic High Level Input Voltage	VIH	-	0.7*IOVCC	-	IOVCC	V	
Logic Low Level Input Voltage	VIL	-	DGND	-	0.3*IOVCC	V	
VCOM Operation							
DC VCOM Amplitude Voltage	VCOM	-	-2.0	-	-0.06	V	Note 3
Source Driver							
Source Output Range	VsOUT	-	0.1	-	VREG1OUT-0.1	V	Note 4
Positive Gamma Reference Voltage	VREG1OUT	-	3.625	-	5.5	V	
Negative Gamma Reference Voltage	VREG2OUT	-	-5.5	-	-3.625	V	
Source Output Setting Time	Tr	Below with 99% precision	-	10	-	uS	Note 3, 4
Output Deviation Voltage (Source Output channel)	Vdev	Sout>=4.2V	-	-	20	mV	Note 3
		4.2V>Sout>0.8V	-	-	15	mV	-
Output Offset Voltage	VOFFSET	-	-	-	35	mV	Note 3
Booster Operation							
Booster (VCIx2) Voltage	DDVDH	-			6	V	
Booster (VCIx2) Voltage	DDVDL	-	-6			V	
Booster (VCIx2 Drop Voltage)	VCI1x2 drop	loading=1mA	-	-	5	%	
Gate Driver High Voltage	VGH	-	10.0	-	20	V	
Gate Driver Low Voltage	VGL	-	-15.0	-	-6.0	V	
Standby mode current consumption (Ta = 25 °C, Interface: DBI and DPI)							
Sleep in mode	VCI	VCI=2.8V	-	100	-	uA	
Deep Standby mode	VCI	IOVCC=1.8V	-	1	-	uA	

Notes:

- Ta = -30 to 70 °C (no damage up to 85°C (at maximum)), IOVCC=1.65V to 3.3V, VCI=2.5V to 3.3V, DGND=0V.
- Supply the digital IOVCC voltage equal to or less than the analog VCI voltage.
- Source channel loading = 10KΩ,30pF/channel
- The maximum value is between 10KΩ,30pF/channel and Gamma setting value.

4.2 Back-Light Unit

Item	Symbol	Min.	Typ.	Max.	Unit	Remark
Current	IF	--	120	--	mA	IF=120mA VF=3.2V
Forward voltage	VF	3.0	3.2	3.4	V	
Chroma	X	0.250	--	0.30		
	Y	0.250	--	0.30		
Uniformity	UBL	80	--	--	%	
Number of LED	-	-	6	--	Piece	-
Backlight Color	White					

- The luminous intensity of LED is strongly dependent on the driving current.
- It is recommended the input of backlight to be constant current rather than constant voltage.

5 TFT-LCM Interface Specification

Pin No	Symbol	Description
1	X(L)	Touch panel pin / left
2	Y(U)	Touch panel pin / up
3	X(R)	Touch panel pin / right
4	Y(D)	Touch panel pin / down
5	GND	Ground(0V)
6	VCI	Power supply(2.8V)
7	IOVCC	Power supply for the logic circuit(1.8V)
8	FMARK	Tearing effect output pin
9	CS	Chip select pin
10	RS	Data/Command control Pin
11	WR/SCL	Write execution control Pin
12	RD	Read execution control Pin
13	SDI	Serial in signal
14	SDO	Serial out signal
15	RESET	Reset signal input
16	GND	Ground(0V)
17-32	DB0~DB15	Data bus
33	A	Backlight anode
34-36	K	Backlight cathode
37	GND	Ground(0V)
38-40	IM0-IM2	Interface Select Pin

6 Timing Characteristics

Please refer to the ILI9488 specification.

7. Optical Specification

The optical characteristics are measured under stable conditions as following notes.

Table 3 Optical Characteristics

Item	Conditions	Min.	Typ.	Max.	Unit	Note
Viewing Angle (CR>10)	Horizontal	θ_{x+}	-	(45)	-	deg. (1),(2),(6),(7), (8)
		θ_{x-}	-	(45)	-	
	Vertical	θ_{y+}	-	(45)	-	
		θ_{y-}	-	(20)	-	
Contrast Ratio	Center	-	(500)	-	-	(1),(3),(6)(7), (8)
Response Time	Rising + Falling	-	(20)	-	ms	(1),(4),(6),(7), (8)
CF Color Chromaticity (CIE1931)	Red x	Typ. -0.03	(0.626)	Typ. +0.03	-	Under C-light
	Red y		(0.334)		-	
	Green x		(0.277)		-	
	Green y		(0.549)		-	
	Blue x		(0.142)		-	
	Blue y		(0.122)		-	
	White x		(0.303)		-	
	White y		(0.325)		-	
NTSC	CIE1931	-	(60)	-	%	(1),(6),(7),(8)
Transmittance	Without POL	-	(15.7)	-	%	(1),(5),(6),(7), (8)

Note 1: The brightness test equipment setup

$I_B=60\text{mA}$, Field= 2° (As measuring "black" image, field= 2° is the best testing condition.)

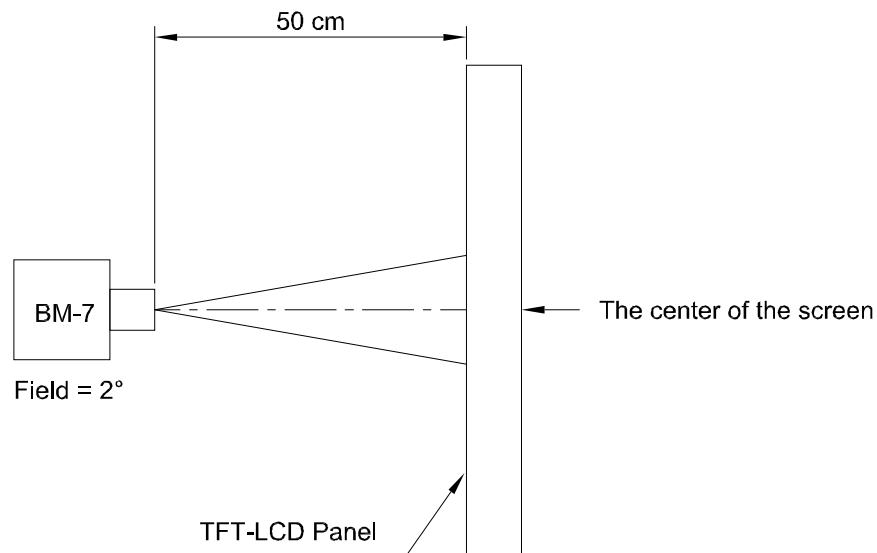

Note 2: Definition of contrast ratio (C.R)

$$C.R = \frac{\text{Brightness When LCD is at "White" State}}{\text{Brightness When LCD is at "Black" State}}$$

Note 3: Definition of response time

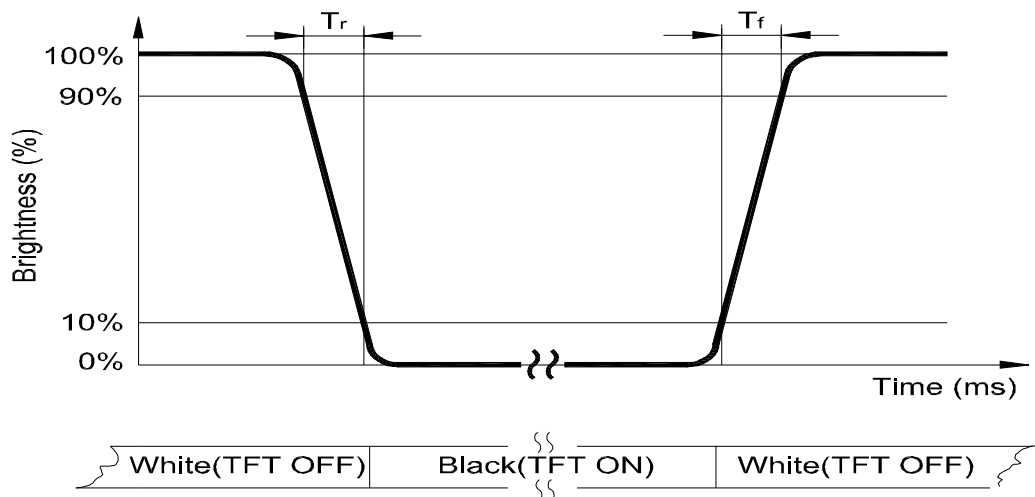

Note 4: Definition of viewing angle

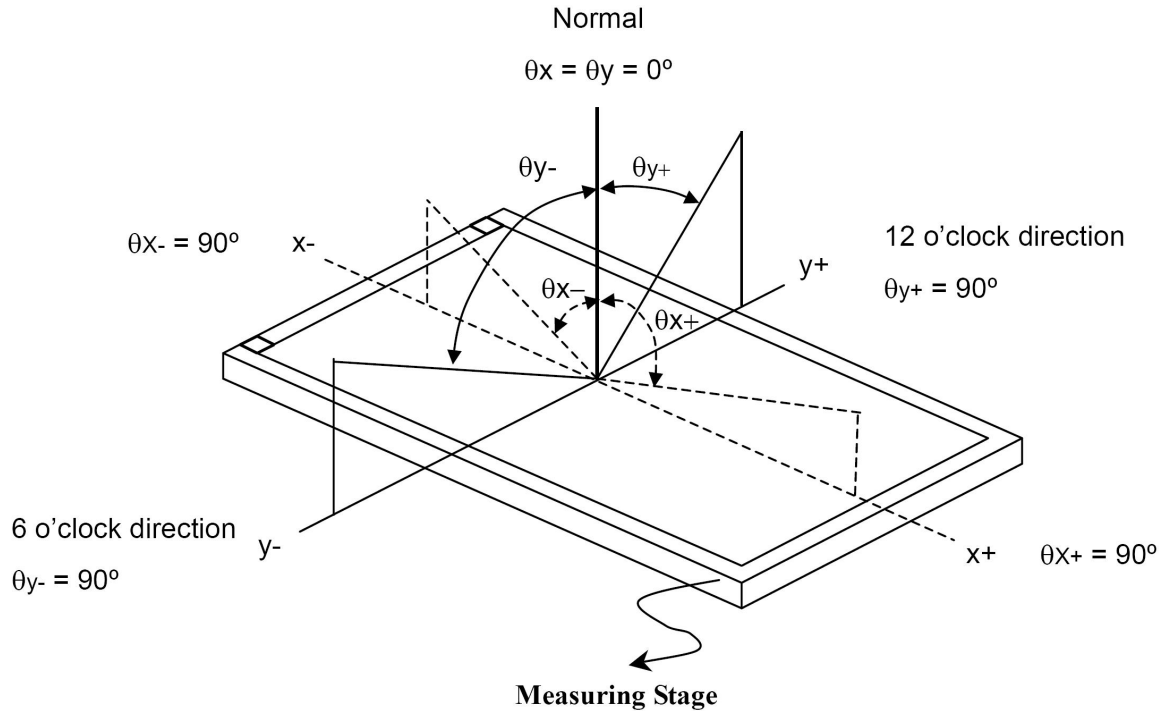

Note 5: Definition of uniformity (Un)

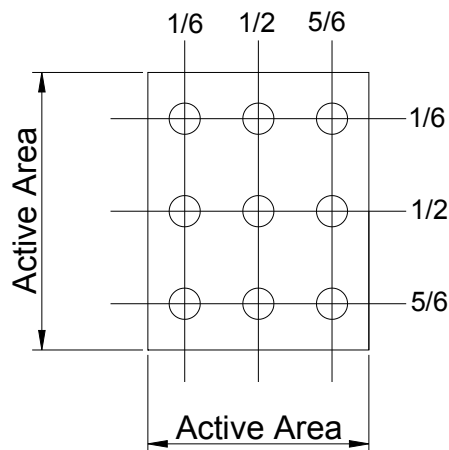

$$U_n = \frac{B_{min}}{B_{max}} \times 100\%$$

深圳上线科技有限公司	Doc.No.:	
	REV : A	PAGE : 11/16
SPEC TITLE DOCUMENT CONTROL SPECIFICATION	EFFECTIVE DATE : 2023-05-05	

8 Environment Absolute Maximum Ratings

Item	Symbol	Min	Max	Unit	Remark
Operation temperature range	Top	-20	70	°C	Ambient
Storage temperature range	Tst	-30	80	°C	Ambient

- Corrosive gas environment is not acceptable.
- TFT-LCD color will change slightly depending on environment temperature. This phenomenon is reversible. Current reduction rate of LED backlight is according to the graph indicated below:

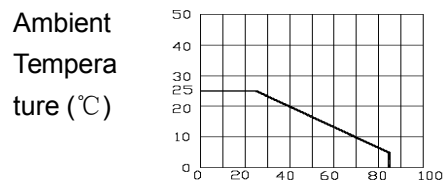

Allowable Forward Current (mA)

9 Reliability Test Items

Item	Test Condition		Criterion
High Temperature Storage	80 °C, 240 hrs		There should be no change which might affect the practical display function when the display quality test is conducted under normal operating condition.
Low Temperature Storage	-30 °C, 240 hrs		
High Temp. & High Humidity Storage	60 °C, 90% RH, 240 hrs		
Vibration Test (Non-operating)	Freq.:10~55~10 Hz, Amp.:1.5mm 1 hr for each direction of X, Y, Z		
Electrostatic Discharge Test (Non-operating)	Terminals	150 pF, 0 Ω, ±300 V, Contact	
	Panel	150 pF, 330 Ω, ±8 KV, Air	
Thermal Shock (Static)	-30°C, 30 min /80°C, 30 min, 20 cycles		
High Temperature Operation	70 °C, 240 hrs		
Low temperature Operation	-20 °C, 240 hrs		
High Temperature & High Humidity (Operating)	50 °C, 90% RH, 240 hrs		
FPC Peeling Strength Test	Pull speed: 50 mm/min, +90°,		> 400gf/cm

10 Inspection Standard

This standard apply to TFT module specification.

1. Inspection condition:

Under daylight lamp 20~40W, product distance inspector'eye 30cm.incline degree 30° .

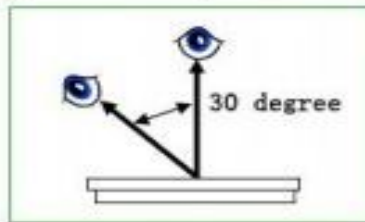

2. Inspection standard

NO.	Item	Inspection standard	Rate															
2.1	Dot	<p>Case of Dot defect is below</p> <p>① Bright Dot (whit spot) : "0"</p> <p>② Dark Dot (black spot) : "0" (In case of Dark Dot on Main TFT LCD)</p> <p>- NG if there's full Dot defect.</p> <p>- Damaged less than the size of sub-pixel is not counted as defect</p> <p>- Dots darker than the size of sub-pixel are not defined as bright dot defect</p> <table border="1"> <thead> <tr> <th>area size (mm)</th> <th>Acceptable number</th> </tr> </thead> <tbody> <tr> <td>$\Phi \leq 0.10$</td> <td>ignore</td> </tr> <tr> <td>$0.10 < \Phi \leq 0.15$</td> <td>3</td> </tr> <tr> <td>$0.15 < \Phi \leq 0.20$</td> <td>2</td> </tr> <tr> <td>$0.25 < \Phi \leq 0.25$</td> <td>1</td> </tr> <tr> <td>$0.25 < \Phi$</td> <td>0</td> </tr> </tbody> </table>	area size (mm)	Acceptable number	$\Phi \leq 0.10$	ignore	$0.10 < \Phi \leq 0.15$	3	$0.15 < \Phi \leq 0.20$	2	$0.25 < \Phi \leq 0.25$	1	$0.25 < \Phi$	0	minor			
area size (mm)	Acceptable number																	
$\Phi \leq 0.10$	ignore																	
$0.10 < \Phi \leq 0.15$	3																	
$0.15 < \Phi \leq 0.20$	2																	
$0.25 < \Phi \leq 0.25$	1																	
$0.25 < \Phi$	0																	
2.2	line	<table border="1"> <thead> <tr> <th colspan="2">Size (mm)</th> <th>Acceptable number</th> </tr> </thead> <tbody> <tr> <td>ignore</td> <td>$W \leq 0.03$</td> <td>ignore</td> </tr> <tr> <td>$L \leq 4.0$</td> <td>$0.03 < W \leq 0.04$</td> <td>2</td> </tr> <tr> <td>$L \leq 4.0$</td> <td>$0.04 < W \leq 0.05$</td> <td>1</td> </tr> <tr> <td></td> <td>$0.05 < W$</td> <td>Treat with dot non-conformance</td> </tr> </tbody> </table>	Size (mm)		Acceptable number	ignore	$W \leq 0.03$	ignore	$L \leq 4.0$	$0.03 < W \leq 0.04$	2	$L \leq 4.0$	$0.04 < W \leq 0.05$	1		$0.05 < W$	Treat with dot non-conformance	
Size (mm)		Acceptable number																
ignore	$W \leq 0.03$	ignore																
$L \leq 4.0$	$0.03 < W \leq 0.04$	2																
$L \leq 4.0$	$0.04 < W \leq 0.05$	1																
	$0.05 < W$	Treat with dot non-conformance																

11 Package

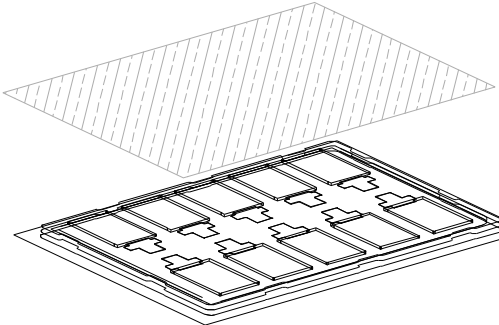
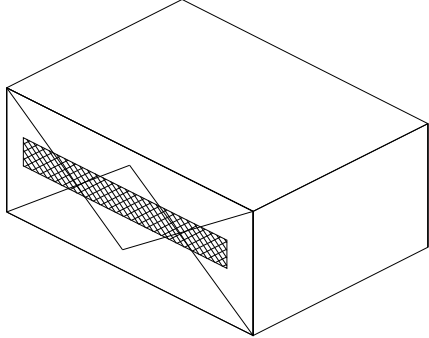
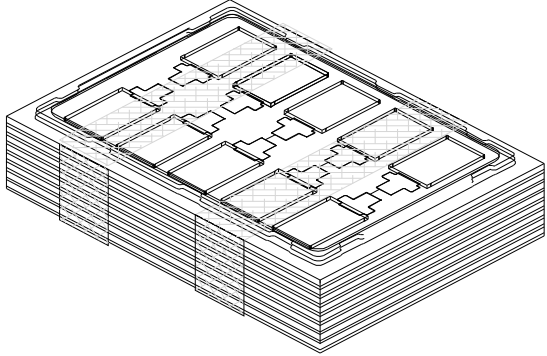
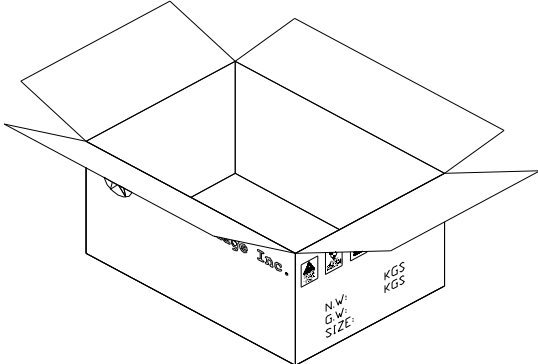
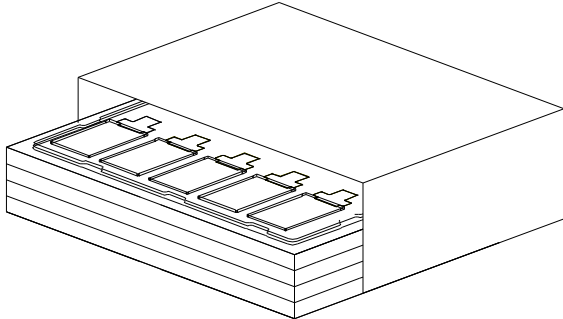
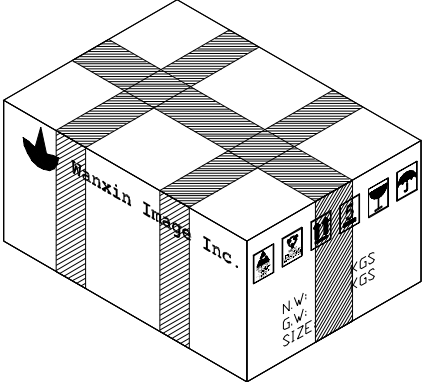
1 	4 
10 pcs per tray + 1 cover (EPE)	Packing bag
2 	5 
15 trays + 1 dummy tray = 150 ps	Putting bag into carton Protected by 2 pieces of cushion EPE sheet
3 	6 
Putting trays into anti-electrostatic bag	Packing carton with sealing tape Carton outline size: 400×295×145 (mm)

深圳上线科技有限公司	Doc.No.:	
	REV : A	PAGE : 14/16
SPEC TITLE DOCUMENT CONTROL SPECIFICATION	EFFECTIVE DATE : 2023-05-05	

12 Precautions

Please pay attentions to the followings as using the LCD module.

12.1 Handling

- (a) Do not apply strong mechanical stress like drop, shock or any force to LCD module. It may cause improper operation, even damage.
- (b) Because the polarizer is very fragile and easy to be damaged, do not hit, press or rub the display surface with hard materials.
- (c) Do not put heavy or hard material on the display surface, and do not stack LCD modules.
- (d) If the display surface is dirty, please wipe the surface softly with cotton swab or clean cloth.
- (e) Avoid using Ketone type materials (e.g. Acetone), Toluene, Ethyl acid or Methyl chloride to clean the display surface. It might damage the touch panel surface permanently. The recommended solvents are water and Isopropyl alcohol.
- (f) Wipe off water droplets or oil immediately.
- (g) Protect the LCD module from ESD. It will damage the LSI and the electronic circuit.
- (h) Do not touch the output pins directly with bare hands.
- (i) Do not disassemble the LCD module.
- (j) Do not lift the FPC of Touch Panel.

12.2 Storage

- (a) Do not leave the LCD modules in high temperature, especially in high humidity for a long time.
- (b) Do not expose the LCD modules to sunlight directly.
- (c) The liquid crystal is deteriorated by ultraviolet. Do not leave it in strong ultraviolet ray for a long time.
- (d) Avoid condensation of water. It may cause improper operation.

深圳上线科技有限公司	Doc.No.:	
	REV : A	PAGE : 15/16
SPEC TITLE DOCUMENT CONTROL SPECIFICATION	EFFECTIVE DATE : 2023-05-05	

- (e) Please stack only up to the number stated on carton box for storage and transportation. Excessive weight will cause deformation and damage of carton box.

12.3 Operation

- (a) When mounting or dismantling the LCD modules, turn the power off.
- (b) Protect the LCD modules from electric shock.
- (c) The Driver IC control algorithms stated above should always obeyed to avoid damaging the LSI and electronic circuit.
- (d) Be careful to avoid mixing up the polarity of power supply for backlight.
- (e) Absolute maximum rating specified above has to be always kept in any case. Exceeding it may cause non-recoverable damage of electronic components or, nevertheless, burning.
- (f) When a static image is displayed for a long time, remnant image is likely to occur.
- (g) Be sure to avoid bending the FPC to an acute shape, it might break FPC.
- (h) Most of the touch screens have air vent to equalize the inside air pressure to the outside one. The air vent must be open and liquid contact must be avoided as the liquid may be absorbed if the liquid is accumulated near the air vent.
- (i) For the fragility of ITO film, it should avoid to use too tapering pen as the input material.

12.4 Touch Panel Mounting Notes

- (a) If a cushion is used between bezel/housing and film must be choose as free as enough to absorb the expansion and contraction to avoid the distortion of film.
- (b) The cushion must be placed out of the Viewing Area.
- (c) Bezel/Housing edge must be posited between Key Area and Viewing Area. The edge enters the Key Area may cause unexpected input if the gap is too narrow or foreign particles like dusts exist between Bezel/Housing and ITO film.
- (d) Mounting example:

深圳上线科技有限公司	Doc.No.:	
	REV : A	PAGE : 16/16
SPEC TITLE DOCUMENT CONTROL SPECIFICATION	EFFECTIVE DATE : 2023-05-05	

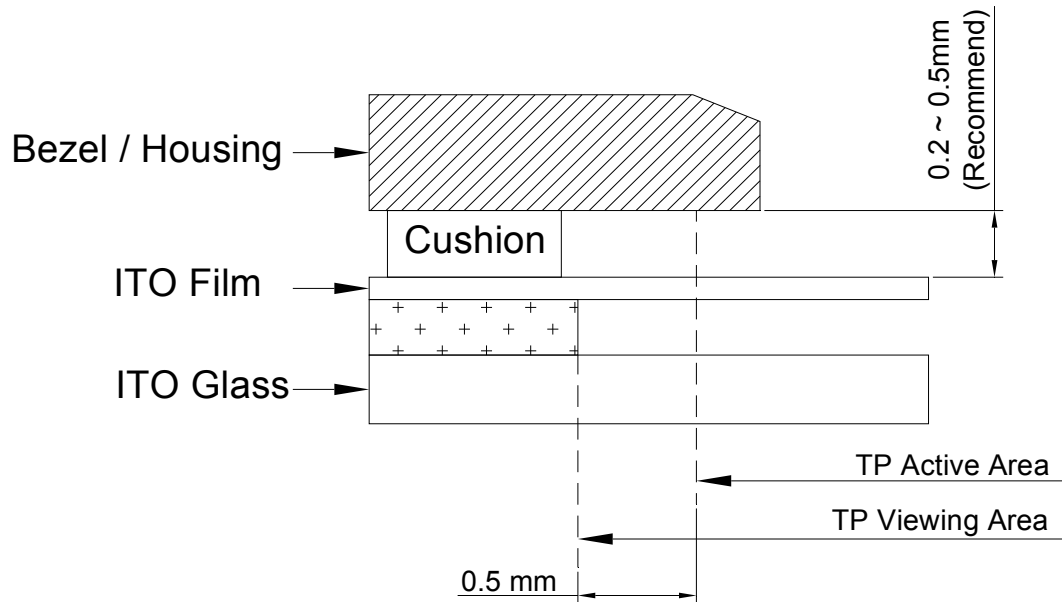

The corner part has conductivity. Do not touch any metal part after mounting.

12.5 Others

- a) If the liquid crystal leaks from the panel, it should be kept away from the eyes or mouth.
- b) For the fragility of polarizer, it is recommended to attach a transparent protective plate over the display surface.
- c) It is recommended to peel off the protection film on the polarizer slowly so that the electrostatic charge can be minimized.

13 Records of Version

Version	Revise Date	Page	Content
A	2023-05-05	All	New released