

1.44 寸集成串口屏

1.44-inch integrated serial port screen



*由于我司会对串口屏模块不定时更新升级，版本号会出现与旧版本不一致，此时硬件软件不会出现不一致的现象，只是升级增强了硬件软件的兼容性。

* Because our company will update and upgrade the serial port screen module irregularly, the version number will be inconsistent with the old version. At this time, the hardware and software will not be inconsistent, but the upgrade will enhance the compatibility of the hardware and software.

修订记录

Revision record

版本 Version	发布者 Publisher	修改内容 Modify the content	修改日期 Date of modification
---------------	------------------	----------------------------	------------------------------

A0	zwj	初版 First edition	2020/10/15

产品概述

Product overview

1.44 寸集成串口屏是一款串口屏模块，点阵分辨率是 128x128。其内置国标一级、二级简体中文字库和英文 ASCII 字符集，同时开放内部点阵 DDRAM，能够在屏幕上的任意位置显示图片及图形。硬件上它提供 UART 接口方式，接线简单。软件驱动方面，用户只要几条简单指令就能设计出美观绚丽的用户界面，从此用户不再需要花费高昂的硬件成本及漫长的开发周期来为设备仪器配置 LCD 彩屏，集成串口屏丰富的片上资源及强大的指令集，是客户项目开发的首选方案。

The 1.44-inch integrated serial screen is a serial screen module with a dot matrix resolution of 128x128. It has built-in simplified Chinese font library and English ASCII character set, and open internal dot matrix DDRAM, which can display pictures and graphics at any position on the screen. In terms of hardware, it provides UART interface mode with simple wiring. In terms of software driver, users can design a beautiful and gorgeous user interface with only a few simple instructions. From then on, users no longer need to spend high hardware costs and a long development cycle to configure LCD color screens for equipment and instruments. The rich on-chip resources and powerful instruction set of the integrated serial port screen are the preferred solution for customer project development.

- 外形尺寸
- Overall dimensions

测量类型 Type of	测量数据 (±0.2) Measured data (± 0.2)
-----------------	--------------------------------------

1.44 寸集成串口屏规格书

1.44-inch Integrated Serial Port Screen Specification

measurement	
外观尺寸 Exterior dimensions	29.0mm*46.61mm*7.2mm

- 显示性能参数
- Displays the performance parameters

参数类型 Parameter type	测量数据 Measurement data	说明 Explain
显示区域(A.A) Display area (A. A)	25.5mm*26.5mm	/
分辨率(ppi) Resolution (PPI)	128*128	/
像素间距 Pixel spacing	0.1992mm*0.2070 mm (H×V)	/
显示颜色 Display color	65K	/
像素布局 Pixel layout	RGB 垂直条状 RGB vertical strip	/
最佳视角 Best viewing angle	12:00 o'clock	/
对比度 Contrast	400:1 (Typ.) (透射) 400:1 (Typ.)	/
背光光源类型 Backlight light source type	WHITE LED	高亮白色 LED 灯, 可发送 BL(0); ——BL(255);调节背光亮度 Highlight white LED, can send BL (0); — — BL (255); adjust backlight brightness
模块亮度 Module brightness	400cd/m2	/
室内外可视 Visible indoors and outdoors	是 Yes	/
DDRAM	32K 显存 32K video memory	开放内部 DDRAM Open internal DDRAM

- 电性能参数
- Electrical performance parameters

1.44 寸集成串口屏规格书

1.44-inch Integrated Serial Port Screen Specification

参数类型 Parameter type	测试条件 Test conditions	最小值 Minimum value	标准值 Standard value	最大值 Maximum value	单位 Unit
工作电压范围 Operating voltage range	输入电压 (VDD:+3.3V.+5.0V 可选);可通过背面元器件区域(R2-5V)、(R4-3.3V)电阻,使用 5V 时电阻应在 R2 位,使用 3.3V 时电阻应在 R4 位,如模块电阻位在 R4(3.3V),使用 5V 电源输入会烧坏主板及相关元器件。 Input voltage (VDD: + 3.3 V. + 5.0 V optional); can be through the rear component area (R2-5V), (R4-3.3 V) resistance, the resistance should be at R2 when using 5V, the resistance should be at R4 when using 3.3 V, if the module resistance is at R4 (3.3 V), using 5V power input will burn out the motherboard and related components.				
		最小值 Minimum value	标准值 Standard value	最大值 Maximum value	单位 Unit
工作电流(5V) Operating current (5V)	背光最亮 The backlight is the brightest	-	80	-	mA
	背光最暗 The backlight is the darkest	-	17	-	mA
工作电流(3.3V) Operating Current (3.3 V)	背光最亮 The backlight is the brightest	-	70	-	mA
	背光最暗 The backlight is the darkest	-	17	-	mA
工作功耗(5V) Power consumption (5V)		85	-	400	mW
工作功耗(3.3V) Operating Power (3.3 V)		57	-	235	mW

- 工作环境参数
- Working environment parameters

参数类型 Parameter type	测试环境 Test environment	最小值 Minimum value	标准值 Standard value	最大值 Maximum value	单位 Unit
工作温度 Operating	-	-20	-	60	°C

temperature					
储存温度 Storage temperature	-	-30	-	70	°C
工作湿度 Operating humidity	25°C	10%	60%	90%	RH
出厂老化 Factory aging 测试 Test	-	-	8	-	H
通讯接口 Communication interface	UART 接口 1.25mm 4Pin UART connector 1.25 mm 4 Pin				

- 接口性能参数
- Interface performance parameters

	最小值 Minimum value	标准值 Standard value	最大值 Maximum value	单位 Unit
串口波特率 Serial port baud rate	9600	115200	115200	Bps
串口接收电 平(RX) Serial port receiving level (RX)	2.8V	3.3V	3.5V	V
串口接收电 平(RX) Serial port receiving level (RX)	2.8V	3.3V	3.5V	V

- 接口定义
- Interface definition

	引脚名称 Pin name	引脚电平 Pin level	功能描述 Functional description
	GND	0	电源接地端 Power supply ground terminal
	RX	5V/3.3V	主控芯片 UART 数据接收端 Main control chip UART data receiving terminal

1.44 寸集成串口屏规格书

1.44-inch Integrated Serial Port Screen Specification

	TX	5V/3.3V	主控芯片 UART 数据发送端 Main control chip UART data sending terminal
	VCC	5V/3.3V	电源供电端 Power supply terminal

注意：如果VCC是3.3V输入时，需要将背面的电阻R4短路、R2开路。模块出厂默认的为5.0V供电输入!!!
Note that if VCC is a 3.3 V input, the resistor R4 on the back needs to be shorted and R2 opened. The module's factory default is 5.0 V supply input!!!

- 硬件接口示意图
- Hardware interface diagram

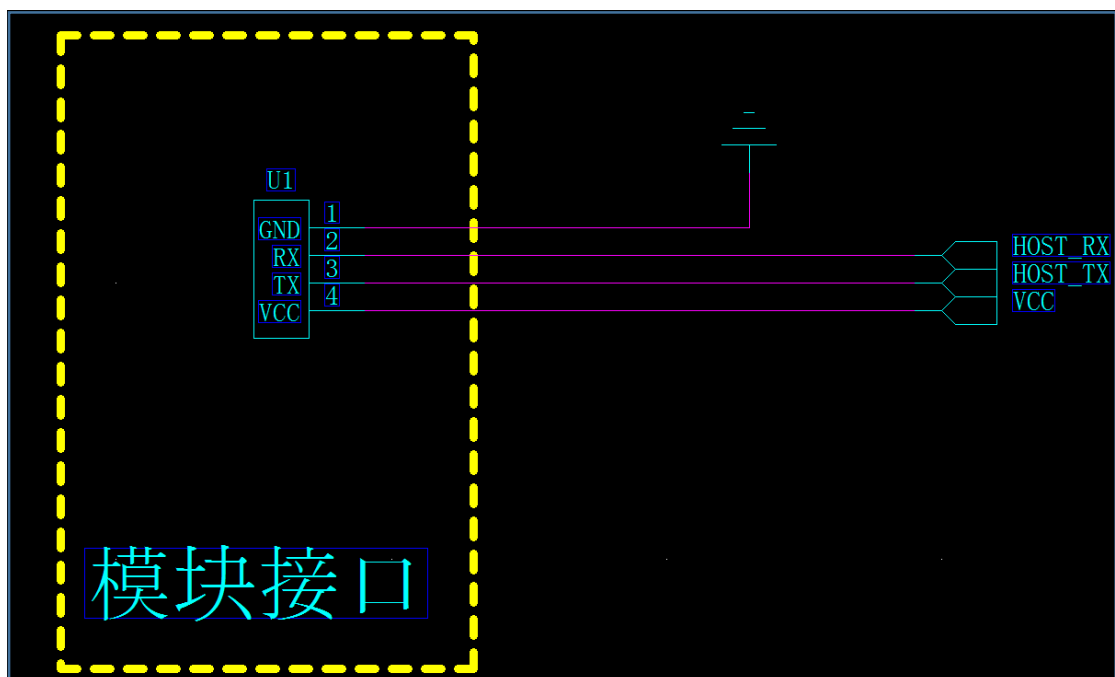

- 电源上电时序
- Power supply power-up sequence

电源给模块供电时，必须保证电压在 80ms 之内稳定在 5V/ 3.3V,如果不满足这个条件，模块有可能会概率性显示不正常的情况。

When the power supply supplies power to the module, the voltage must be stabilized at 5V/3.3V within 80ms. If this condition is not met, the module may have abnormal probability display.

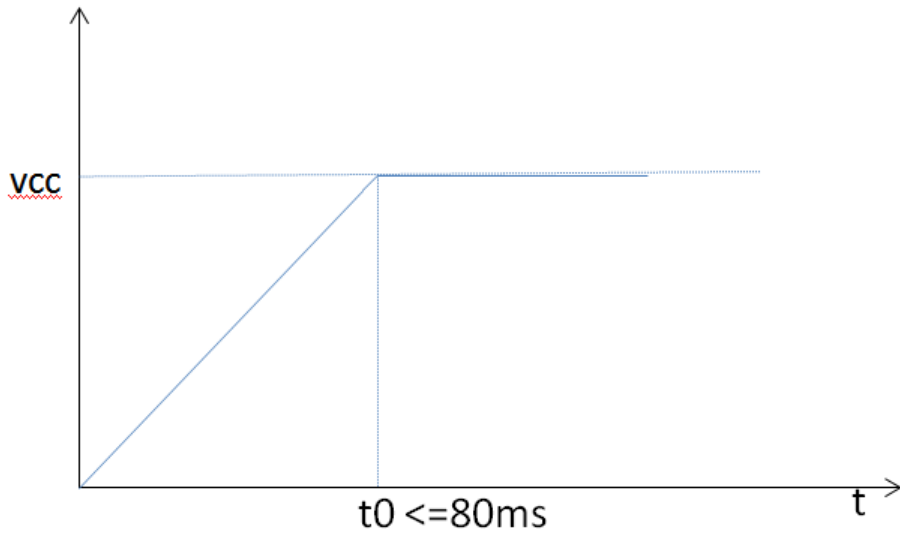

- 软件上电流程
- Software power-on process

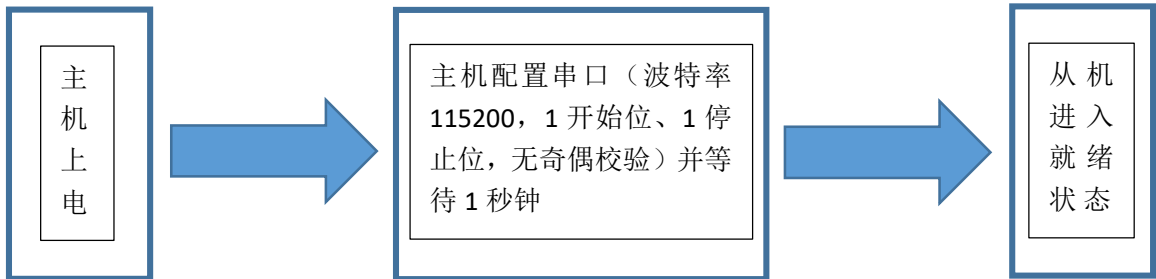

注意：上电等待 1 秒是模块正常工作的前提，如果没有足够的等待时间模块有可能无法正常的接收指令而导致系统出错。

Note: Power on and wait for 1 second is the prerequisite for normal operation of the module. If there is not enough waiting time, the module may not be able to receive instructions normally, resulting in system errors.

- 存储器特性
- Memory characteristics

存储器类别 Memory class	参数类别 Parameter category	最小值 Minimum value	标准值 Standard value	最大值 Maximum value	单位 Unit
	字库储存空间	-	2	-	MB

Font storage space					
图片储存空间 Picture storage space	-	2	-		MB
全屏图片储存数量 Number of full-screen images saved	0	-	64		张/幅 Sheet/width
图片可用储存算法 Picture available storage algorithm	裸数据存储 Raw data storage				

- 内置字库参数
- Built-in font parameters

字体类型 Font type	内置字号参数 Built-in font size parameter
中文字体 Chinese font	8192 个 GB2312 16*16 24*24 32*32 中文字体 8192 GB2312 16 * 16 24 * 24 32 * 32 Chinese fonts
英文字体 English font	ASCII 英文字体 8*16 16*24 16*32 ASCII font 8 * 16 16 * 24 16 * 32

- 支持软件
- Support Software

类型 Type	功能描述 Functional description	使用方式 How to use
SunStudio.exe	串口调试、指令验证、图片下载 Serial debugging, instruction verification, picture download	参考：集成串口屏应用文档、集成串口屏指令集、软件使用说明 Reference: integrated serial port screen application document, integrated serial port screen instruction set, and software instructions

- 内置功能
- Built-in features

功能类型 Function type	支持 Support	不支持 Not supported	功能类型 Function type	支持 Support	不支持 Not supported
中文字库 Chinese font	√		超宽视角 Super wide	√	

library			viewing angle		
英文字库 English font library	√		图像功能 Image function	√	
横竖屏切换 Switch between landscape and portrait	√		真彩显示 True color display	√	
画图函数 Drawing function	√		背光调节 Backlight adjustment	√	
BTN 函数 BTN function	√		开机 LOGO Boot LOGO	√	

- 可靠性测试
- Reliability testing

序号 Serial number	可靠性内容 Reliability content	数量 Quantity	测试条件 Test conditions	判断标准 Criteria for judgment
1	高温高湿性能 High temperature and high humidity performance	5	温度 70 °C、湿度 85% 的环境中放置 240H，在常温常湿环境下放置2H后测定 It shall be placed for 240h in an environment with a temperature of 70 °C and a humidity of 85%, and measured after being placed for 2h in a normal temperature and humidity environment	外观无开裂、无结露、变色、腐蚀、明显变形；功能无缺笔、缺画，输入电流无异常。 The appearance shall be free of cracking, condensation, discoloration, corrosion and obvious deformation; There is no missing pen or picture in the function, and the input current is normal.
2	高温性能 High	5	温度70°C的环境中放置 240H，取出后 Place for 240H in an environment with a temperature of 70 °C,	外观无开裂、无结露、变色、腐蚀、明显变形；功能无缺笔、缺画，输入电流无异常。 The appearance shall

1.44 寸集成串口屏规格书

1.44-inch Integrated Serial Port Screen Specification

	temperature performance		and then take out 在常温常湿环境下放置 2H 后测定 Determine after being placed for 2 H in normal temperature and humidity environment	be free of cracking, condensation, discoloration, corrosion and obvious deformation; There is no missing pen or picture in the function, and the input current is normal.
3	低温性能 Low temperature performance	5	温度-30°C的环境中放置 240H,取出后 Place for 240H at -30 °C, and take out 在常温常湿环境下放置 2H后测定 Determine after being placed for 2 H in normal temperature and humidity environment	外观无开裂、无结露、变色、腐蚀、明显变形； 功能无缺笔、缺画，输入电流无异常。 The appearance shall be free of cracking, condensation, discoloration, corrosion and obvious deformation; There is no missing pen or picture in the function, and the input current is normal.
4	冷热冲击实验 Cold and hot shock test	5	调节试验槽温度做冷热冲击测试：70°C (30分钟)→温度下降到-20°C (5分钟)→-30°C(30分钟)→温度上升到70°C (5分钟)至此温度时间变化为一个循环（如下图）。累计测试 100 个循环，试验结束后取出，在常温常湿环境下放置2H后测试。 Adjust the temperature of the test tank for cold and hot shock test: 70 °C (30 minutes) → the temperature drops to -20 °C (5 minutes) → -30 °C (30 minutes) → the temperature rises to 70 °C (5 minutes), and the time change of the temperature is a cycle (as shown in the figure below). Test for 100	外观无开裂、无结露、变色、腐蚀、明显变形； 功能无缺笔、缺画，输入电流无异常。 The appearance shall be free of cracking, condensation, discoloration, corrosion and obvious deformation; There is no missing pen or picture in the function, and the input current is normal.

1.44 寸集成串口屏规格书

1.44-inch Integrated Serial Port Screen Specification

			cycles in total, take out after the test, and test after being placed for 2 H in a normal temperature and humidity environment.	
5	ESD 测试 ESD test	5	空气放电 +/-8KV Air discharge +/-8KV 接触放电 +/-4KV Contact discharge +/-4KV 方法：四边及中心位置 10 次/点 Method: 10 times/point at four sides and central position	功能无缺笔、缺画，输入电流无异常。 There is no lack of pen and picture in the function, and the input current is normal.

- 结构图纸
- Structural drawings

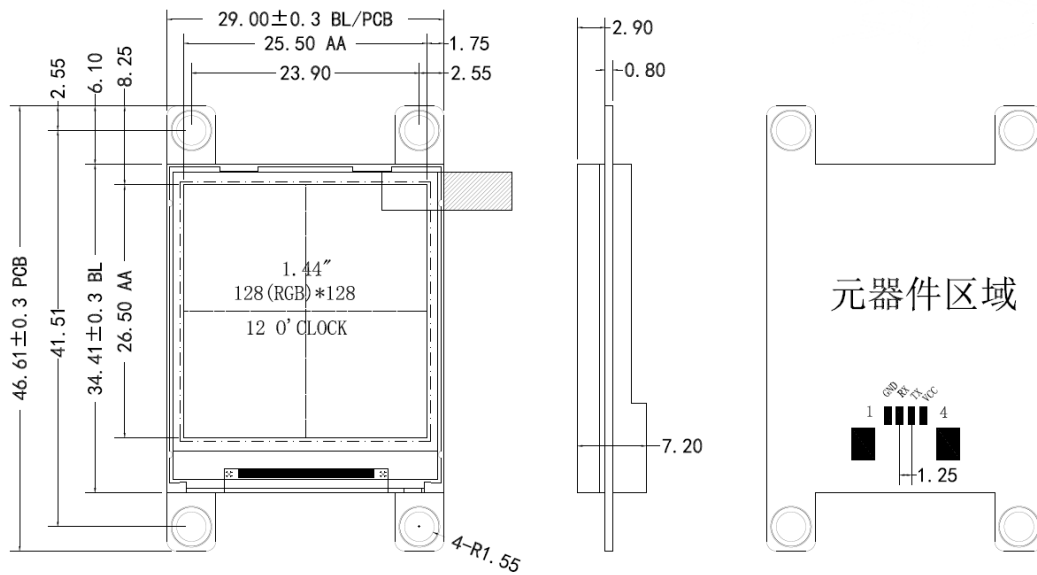

- 指令列表
- List of instructions

指令名称 Instruction name	指令说明 Instruction description		示例代码 Sample code	备注 Remark	
获取版本信息指令 Acquire version information instruction	指令 Instruction	VER;	查询方式 (推荐) Query method (recommended)	UartSend("VER;\r\n"); CheckBusy();	CheckBusy()的实现查看工程代码 CheckBusy () Implementation View Engineering Code time 的值>40(ms) Value of time > 40 (ms)
	使用说明 Instructions for use	获取模块固化的版本信息,并显示在屏幕上 Obtain the fixed version information of the module and display it on the screen	延时方式 (不推荐) Delay mode (not recommended)	UartSend("VER;\r\n");Delaysms(time);	
设置波特率指令 Set baud rate command	指令 Instruction	BPS(bps);	查询方式 (推荐) Query method (recommended)	UartSend("BPS(9600);\r\n");CheckBusy();	此命令有掉电保护功能,但如果系统供电不稳定或者在保存命令执行时掉电,将会造成系统参数数据被覆盖,导致显示异常,建议在sunstudio上面先修改好,再装机运行!! This command has the function of power failure protection. However, if the system power supply is unstable or the power
	使用说明 Instructions for use	BPS 为指令码,括号内为参数。如果把波特率设置为 9600,则 BPS(9600); BPS is the instruction code, and the parameters are in parentheses. If you want to set the baud rate to 9600, BPS	延时方式 (不推荐) Delay mode (not recommended)	UartSend("BPS(9600);\r\n");Delaysms(time);	

1.44 寸集成串口屏规格书

1.44-inch Integrated Serial Port Screen Specification

		(9600);			fails during the execution of the save command, the system parameter data will be overwritten, resulting in abnormal display. It is recommended to modify it on the sunstudio first, and then install and run it! time 的值>235(ms) Value of time > 235 (ms)
清屏指令 Clear screen command and	指令 Instruction	CLR(c);	查询方式 (推荐) Query method (recommended)	UartSend("CLR(1);\r\n");CheckBusy();	time 的值>25(ms) Value of time > 25 (ms)
	使用说明 Instructions for use	CLR 为指令码, c 为清屏使用的背景颜色, c 的值在 0~63 之间具体编码见下面颜色列表。 CLR is the command code, C is the background color used to clear the screen, and the value of C is between 0 and 63. See the color list below for the specific code.	延时方式 (不推荐) Delay mode (not recommended)	UartSend("CLR(1);\r\n");Delaysms(time);	
Flash 的图片显示指令 Flash image display instruction	指令 Instruction	FSIMG(addr,x,y,w,h,m);	查询方式 (推荐) Query method (recommended)	UartSend("FSIMG(2097152,0,0,128,128,0);\r\n");CheckBusy();	time 的值>65(ms) Value of time > 65 (ms)
	使用说明 Instructions for use	FSIMG 为指令码 FSIMG is the instruction code addr 为图片存储在 flash 的开始地址 Addr is the starting address where the image is stored in flash (x, y)为图片显示在屏幕上面的起始位置 (X, y) is the starting position of the picture displayed on the screen w 为图片的宽度 W is the width of the picture h 为图片的高度 H is the height of the picture m 为图片显示方式: 0 为正常显示, 1 为透明显示。 M is the picture display mode; 0 is the normal display. 1 is a transparent display.	延时方式 (不推荐) Delay mode (not recommended)	UartSend("FSIMG(2097152,0,0,128,128,0);\r\n"); Delaysms(time);	
屏幕切换指令 Screen switching command and	指令 Instruction	DIR(d);	查询方式 (推荐) Query method (recommended)	UartSend("DIR(1);\r\n");CheckBusy();	time 的值>20(ms) Value of time > 20 (ms)
	使用说明 Instructions for use	DIR 为指令码 DIR is the instruction code d 为方向选择参数 D is the direction selection parameter d=0 为默认原始竖屏方向	延时方式 (不推荐) Delay mode (not recommended)	UartSend("DIR(1);\r\n"); Delaysms(time);	

		<p>D = 0 is the default original portrait orientation</p> <p>d=1 为原始竖屏方向逆时针旋转 90° 的横屏。</p> <p>D = 1 is a landscape screen rotated 90 ° counterclockwise from the original portrait orientation.</p> <p>d=2 为 d=1 顺时针旋转 180°的竖屏状态</p> <p>D = 2 is the portrait state with d = 1 rotated clockwise by 180 °</p> <p>d=3 为 d=1 顺时针旋转 180 的横屏状态。</p> <p>D = 3 is a landscape state in which d = 1 is rotated clockwise by 180.</p>			
设置背光灯的亮度 Set the brightness of the backlight	指令 Instruction	BL(c);	查询方式 (推荐) Query method (recommended)	UartSend("BL(4);\r\n");CheckBusy();	time 的值>15(ms) Value of time > 15 (ms)
	使用说明 Instructions for use	<p>BL 为指令码</p> <p>BL is the instruction code</p> <p>c 为背光灯的亮度值, 调节的范围为: 0~255, 其中 0 为全亮显示, 255 为关闭显示</p> <p>C is the brightness value of the backlight, and the adjustment range is 0 ~ 255, where 0 is the full bright display, and 255 is the off display.</p>	延时方式 (不推荐) Delay mode (not recommended)	UartSend("BL(4);\r\n"); Delaysms(time);	
画点指令 Draw a dot comm and	指令 Instruction	PS(x,y,c);	查询方式 (推荐) Query method (recommended)	UartSend("PS(0,0,3);\r\n");CheckBusy();	time 的值>20(ms) Value of time > 20 (ms)
	使用说明 Instructions for use	<p>PS 为指令码</p> <p>PS is the instruction code</p> <p>(x,y)为显示的起始位置</p> <p>(X, y) is the starting position of the display</p> <p>c 为点的颜色, c 的参数见色表</p> <p>C is the color of the point, and the parameters of C are shown in the color table</p>	延时方式 (不推荐) Delay mode (not recommended)	UartSend("PS(0,0,3);\r\n"); Delaysms(time);	
画线指令 Line drawin g comm and	指令 Instructio n	PL(xs,ys,xe,ye,c);	查询方式 (推荐) Query method (recommended)	UartSend("PL(0,0,90,90,1);\r\n");CheckBus y();	time 的值>30(ms) Value of time > 30 (ms)
	使用说明 Instructions for use	<p>PL 为指令码,</p> <p>PL is an instruction code,</p> <p>(xs,ys) 为显示起点位置</p> <p>(Xs, ys) is the display start position</p> <p>(xe,ye) 为显示终点位置</p> <p>(Xe, ye) is the displayed end position</p> <p>c 为线的颜色, c 的参数内容见色表</p> <p>C is the color of the line, and the parameter content of C is shown in the color table</p>	延时方式 (不推荐) Delay mode (not recommended)	UartSend("PL(0,0,90,90,1);\r\n");Delaysms(ti me) ;	

1.44 寸集成串口屏规格书

1.44-inch Integrated Serial Port Screen Specification

画框指令 Picture frame command and	指令 Instruction	BOX(xs,ys,xe,ye,c);	查询方式 (推荐) Query method (recommended)	UartSend("BOX(0,0,100,100,1);\r\n");CheckBusy();	time 的值>40(ms) Value of time > 40 (ms)
	使用说明 Instructions for use	BOX 为指令码 BOX is the instruction code (xs,ys) 为显示起点位置 (Xs, ys) is the display start position (xe,ye) 为显示终点位置 (Xe, ye) is the displayed end position c 为方框的颜色, c 的参数内容见色表 C is the color of the box, and the parameter content of C is shown in the color table	延时方式 (不推荐) Delay mode (not recommended)	UartSend("BOX(0,0,100,100,1);\r\n");Delaysms(time);	
画填充框指令 Draw fill box command and	指令 Instruction	BOXF(xs,ys,xe,ye,c);	查询方式 (推荐) Query method (recommended)	UartSend("BOXF(0,0,100,100,1);\r\n");CheckkBusy();	time 的值>40(ms) Value of time > 40 (ms)
	使用说明 Instructions for use	BOXF 为指令码 BOXF is an instruction code (xs,ys) 为显示起点位置 (Xs, ys) is the display start position (xe,ye) 为显示终点位置 (Xe, ye) is the displayed end position c 为方框的颜色, c 的参数内容见色表 C is the color of the box, and the parameter content of C is shown in the color table	延时方式 (不推荐) Delay mode (not recommended)	UartSend("BOXF(0,0,100,100,1);\r\n");Delaysms(time);	
画圆指令 Draw a circle command and	指令 Instruction	CIR(x,y,r,c);	查询方式 (推荐) Query method (recommended)	UartSend("CIR(10,10,5,2);\r\n");CheckBusy();	time 的值>25(ms) Value of time > 25 (ms)
	使用说明 Instructions for use	CIR 为指令码 CIR is the instruction code (x,y)为圆心的位置 (X, y) is the position of the center of the circle r 为圆的半径, c 为圆的颜色 R is the radius of the circle and C is the color of the circle	延时方式 (不推荐) Delay mode (not recommended)	UartSend("CIR(10,10,5,2);\r\n");Delaysms(time);	
画填充圆指令 Draw Filled Circle Command and	指令 Instruction	CIRF(x,y,r,c);	查询方式 (推荐) Query method (recommended)	UartSend("CIRF(10,10,5,2);\r\n");CheckBusy();	time 的值>30(ms) Value of time > 30 (ms)
	使用说明 Instructions for use	CIRF 为指令码 CIRF is an instruction code (x,y)为圆心的位置 (X, y) is the position of the center of the circle r 为圆的半径, c 为圆的颜色 R is the radius of the circle and C is the color of the circle	延时方式 (不推荐) Delay mode (not recommended)	UartSend("CIRF(10,10,5,2);\r\n");Delaysms(time);	
设置背景色指令	指令 Instruction	SBC(c);	查询方式 (推荐) Query method (recommended)	UartSend("SBC(1);\r\n");CheckBusy();	此指令配合 DCV 指令用于确定字体下面的底色。 This command is used in

1.44 寸集成串口屏规格书

1.44-inch Integrated Serial Port Screen Specification

Set Background Color Command	使用说明 Instructions for use	SBC 为指令码 The SBC is an instruction code c 为背景的颜色值 C is the color value of the background c 的范围在 0~63 之间 The range of C is between 0 and 63	延时方式 (不推荐) Delay mode (not recommended)	UartSend("SBC(1);\r\n"); Delaysms(time);	conjunction with the DCV command to determine the underlying color of the font. time 的值>15(ms) Value of time > 15 (ms)
显示 16 点高的透明字符指令 Command to display transparent characters 16 points high	指令 Instruction	DC16(x,y,*str,c);	查询方式 (推荐) Query method (recommended)	UartSend("DC16(30,30,'中国';15);\r\n");CheckBusy(); UartSend ("" DC16 (30,30, 'China', 15); \ R \ n ""); CheckBusy ();	time 的值>30(ms) Value of time > 30 (ms)
使用说明 Instructions for use	DC16 为指令码 DC16 is the command code (x,y)为字符的开始位置, (X, y) is the start position of the character, *str 为字符串的内容 The contents of a string where * str is a character c 为字符的颜色 C is the color of the character	延时方式 (不推荐) Delay mode (not recommended)	UartSend("DC16(30,30,'中国',15);\r\n"); Delaysms(time); UartSend ("" DC16 (30,30, 'China', 15); \ R \ n ""); Delaysms(time);		
显示 24 点高的透明字符指令 Command to display transparent character command and	指令 Instruction	DC24(x,y,*str,c);	查询方式 (推荐) Query method (recommended)	UartSend("DC24(30,46,'中国';1);\r\n");CheckBusy(); UartSend ("" DC24 (30,46, 'China', 1); \ R \ n ""); CheckBusy ();	time 的值>35(ms) Value of time > 35 (ms)
使用说明 Instructions for use	DC24 为指令码 DC24 is the command code (x,y)为字符的开始位置 (X, y) is the start position of the character *str 为字符串的内容 * str is the contents of the string c 为字符的颜色 C is the color of the character	延时方式 (不推荐) Delay mode (not recommended)	UartSend("DC24(30,46,'中国',1);\r\n"); Delaysms(time); UartSend ("" DC24 (30,46, 'China', 1); \ R \ n ""); Delaysms(time);		
显示 32 点高的透明字符指令 Command to display 32 dot high transparent character command	指令 Instruction	DC32(x,y,*str,c);	查询方式 (推荐) Query method (recommended)	UartSend(" DC32(30,80,'中国';1);\r\n");CheckBusy(); UartSend ("" DC32 (30,80, 'China', 1); \ R \ n ""); CheckBusy ();	time 的值>40(ms) Value of time > 40 (ms)
使用说明 Instructions for use	DC32 为指令码 DC32 is the command code (x,y)为字符的开始位置 (X, y) is the start position of the character *str 为字符串的内容 * str is the contents of the string c 为字符的颜色 C is the color of the character	延时方式 (不推荐) Delay mode (not recommended)	UartSend(" DC32(30,80,'中国',1);\r\n"); Delaysms(time); UartSend ("" DC32 (30,80, 'China', 1); \ R \ n ""); Delaysms(time);		

1.44 寸集成串口屏规格书

1.44-inch Integrated Serial Port Screen Specification

and					
显示 16 点高的带底色的字符指令 Display 16-point high character command with background color	指令 Instruction	DCV16(x,y,*str,c);	查询方式 (推荐) Query method (recommended)	UartSend("SBC(15);DCV16(30,102,'中国';1);\r\n");CheckBusy(); UartSend ("" SBC (15); DCV16 (30,102, 'China', 1); \ R \ n ""); CheckBusy ();	time 的值>30(ms) Value of time > 30 (ms)
	使用说明 Instructions for use	DCV16 为指令码 DCV16 is the command code (x,y)为字符的开始位置 (X, y) is the start position of the character *str 为字符串的内容 * str is the contents of the string c 为字符的颜色 C is the color of the character	延时方式 (不推荐) Delay mode (not recommended)	UartSend("SBC(15);DCV16(30,102,'中国';1);\r\n"); Delays(time); UartSend ("" SBC (15); DCV16 (30,102, 'China', 1); \ R \ n ""); Delays(time);	
显示 24 点高的带底色的字符指令 Display 24-point high character command and with background color	指令 Instruction	DCV24(x,y,*str,c);	查询方式 (推荐) Query method (recommended)	UartSend("SBC(15);DCV24(30,108,'中国';1);\r\n");CheckBusy(); UartSend ("" SBC (15); DCV24 (30,108, 'China', 1); \ R \ n ""); CheckBusy ();	time 的值>35(ms) Value of time > 35 (ms)
	使用说明 Instructions for use	DCV24 为指令码 DCV24 is the command code (x,y)为字符的开始位置 (X, y) is the start position of the character *str 为字符串的内容 * str is the contents of the string c 为字符的颜色 C is the color of the character	延时方式 (不推荐) Delay mode (not recommended)	UartSend("SBC(15);DCV24(30,108,'中国';1);\r\n"); Delays(time); UartSend ("" SBC (15); DCV24 (30,108, 'China', 1); \ R \ n ""); Delays(time);	
显示 32 点高的字符带底色的指令 Display 32-dot high character	指令 Instruction	DCV32(x,y,*str,c);	延时方式 (推荐) Delay mode (recommended)	UartSend(" SBC(15);DCV32(30,108,'中国';1);\r\n");CheckBusy(); UartSend ("" SBC (15); DCV32 (30,108, 'China', 1); \ R \ n ""); CheckBusy ();	time 的值>40 (ms) Value of time > 40 (ms)
	使用说明 Instructions for use	DCV32 为指令码 DCV32 is the command code (x,y)为字符的开始位置 (X, y) is the start position of the character *str 为字符串的内容	延时方式 (不推荐) Delay mode (not recommended)	UartSend(" SBC(15);DCV32(30,108,'中国';1);\r\n"); Delays(time); UartSend ("" SBC (15); DCV32 (30,108, 'China', 1); \ R \ n ""); Delays(time);	

ter with backgr ound color comm and		* str is the contents of the string c 为字符的颜色 C is the color of the character			
显示 Butto n 指令 Displa ys the Button directi ve	指令 Instructio n	BTN(x,y,w,h,*str,style,frame_color,F color,Bcolor);	查询方式 (推荐) Query method (recommended)	UartSend("BTN(20,80,32,16,'按钮 ';1,0,1,4);\r\n");CheckBusy(); UartSend ("" BTN (20,80,32,16, 'button', 1, 0, 1, 4); \ R \ n ""); CheckBusy ();	time 的值>45(ms) Value of time > 45 (ms)
	使用说明 Instructions for use	BTN 为指令码 BTN is the instruction code (x,y) 为 Button 的开始位置 (X, y) is the starting position of the Button w 是 button 的宽度 W is the width of the button h 是 button 的高度 H is the height of the button *str 为字符串的内容 * str is the contents of the string style 为可选的样式 Style is an optional style frame_color 指定纯色框的颜色 Frame _ color Specifies the color of a solid color frame Fcolor 为字符的颜色 Fcolor is the color of the character Bcolor 为背景颜色 Bcolor is the background color (见下面样式列表) (See list of styles below)	延时方式 (不推 荐) Delay mode (not recommended)	UartSend("BTN(20,80,32,16,'按钮 ';1,0,1,4);\r\n"); Delayms(time); UartSend ("" BTN (20,80,32,16, 'button', 1, 0, 1, 4); \ R \ n ""); Delayms(time);	
模式切 换指令 Mode switchi ng instruc tion	指令 Instructio n	MODE_CFG(m);	查询方式 (推荐) Query method (recommended)	UartSend("MODE_CFG(0);\r\n");CheckBusy ();	备注: m=1 和 m=2 这两条命令 不能同时使用; 此命令有掉电保护 功能, 但如果系统供电不稳定或者 在保存命令执行时, 掉电将会造成 系统参数数据被覆盖, 导致显示异 常, 建议在 sunstudio 上面先发 好命令, 在装机运行, 可避免这个 问题。 Note: The m = 1 and m = 2 commands cannot be used simultaneously. This command has the function of power failure protection. However, if the system power supply is unstable or when the save command is executed, the power failure will cause the system parameter data to be overwritten, resulting in
	使用说明 Instructions for use	此指令用于切换集成屏内部的模式开 关 This command is used to toggle the mode switch inside the integrated panel 当 m=0 时, 集成屏工作模式 When m = 0, the integrated screen is in operation mode. 当 m=1 时, 集成屏开机能够载入用户 预先设定好的代码, 如开机 logo 和开 机动画等 When m = 1, the integrated screen can load the code preset by the user, such as startup logo and startup	延时方式 (不推 荐) Delay mode (not recommended)	UartSend("MODE_CFG(0);\r\n"); Delaysms(time);	

1.44 寸集成串口屏规格书

1.44-inch Integrated Serial Port Screen Specification

		<p>animation</p> <p>当 m=2 时, FSIMG(addr,x,y,w,h,m); 指令的 addr 参数自动切换成序列, 比如 FSIMG(2097152,0,0,128,128,0); 指令需要输入 2097152 切换到模式 2 时,</p> <p>When m = 2, FSIMG (addr, X, y, w, H, m); the addr parameter of the instruction automatically switches to a sequence, such as FSIMG (2097152,0,0,128,128,0); the instruction requires the input 2097152 to switch to mode 2,</p> <p>直接使用序号 0 就可以 FSIMG(0,0,0,128,128,0); FSIMG (0,0,0,128,128,0) can be achieved by directly using the sequence number 0;</p>			<p>abnormal display. It is recommended to send the command on sunstudio first and run it after installation to avoid this problem.</p> <p>time 的值>230(ms) Value of time > 230 (ms)</p>
	指令 Instruction	BOOT_START(num);	查询方式 (推荐) Query method (recommended)	/	<p>系统上电后会依次执行写入的每个命令</p> <p>Each command that is written is executed in turn when the system is powered up</p>
上电启动设置指令 Power -on start setting comm and	使用说明 Instructions for use	<p>指令用于开机时运行预先载入的指令或者指令集, 其中 num 为指令的字节数, 含指令分隔符 (;) 和结束符(\r\n). 此指令通过 sunstudio 写入, 要完成写入的功能必须完成 3 个步骤: 1.发送 BOOT_START(num);</p> <p>The instruction is used to run the preloaded instruction or instruction set when booting, where num is the byte number of the instruction, including the instruction separator (;) and the end character (\ R \ n). This instruction is written by sunstudio, and three steps must be completed to complete the writing function: 1. Send the BOOT _ START (num);</p> <p>2.等待模块回复 OK 后, 再将要写入的字符串 num 个字符一次写入到模块中, 等待模块回复 OK. 3 把模块的操作模式切换成 1, 即 MODE_CFG(1);</p> <p>2.After waiting for the module to reply OK, write the num characters of the character string to be written into the module at one time, and wait for the module to reply OK. 3 Switch the operation mode of the module to 1, that is, MODE _ CFG (1);</p>	延时方式 (不推荐) Delay mode (not recommended)	<p>例如: 1.BOOT_START(123);</p> <p>For example: 1. BOOT _ START (123); 2.CLR(15);DELAYMS(400);CLR(0);DELAYMS(400);BOX(0,0,105,127,1);DELAYMS(600);CLR(0);DELAYMS(400);FSIMG(2097152,0,0,6,100,0); 3. MODE_CFG(1);</p>	<p>备注: 此命令有掉电保护功能, 但如果系统供电不稳定或者在保存命令执行时, 掉电将会造成系统参数数据被覆盖, 导致显示异常, 需在 sunstudio 上面先发好命令, 再装机运行, 可避免这个问题。</p> <p>Note: This command has the function of power failure protection. However, if the system power supply is unstable or when the save command is executed, the power failure will cause the system parameter data to be overwritten, resulting in abnormal display. It is necessary to send the command on the sunstudio first, and then install and run it to avoid this problem.</p>

颜色列表 (c从0~63)

Color list (C from 0 to 63)

0	1	2	3	4	5	6	7
8	9	10	11	12	13	14	15
16	17	18	19	20	21	22	23
24	25	26	27	28	29	30	31
32	33	34	35	36	37	38	39
40	41	42	43	44	45	46	47
48	49	50	51	52	53	54	55
56	57	58	59	60	61	62	63

Button指令带框文本 style样式列表

Button directive boxed text style list

style	指定的样式 The specified style
0	此BTN不带框，即为纯文本，等同于DC和DCV指令的效果 This BTN is plain text without a box and is equivalent to the effect of the DC and DCV commands
1	此BTN带下压框，模拟按钮按下的效果 This BTN has a push-down box that simulates the effect of a button press.
2	此BTN带抬起框，模拟按钮抬起的效果 This BTN has a lifting box to simulate the effect of a button lifting
4	此BTN带由frame_color指定的颜色框

	This BTN has a color box specified by frame _ color
8	此BTN没有底色 This BTN has no background color

如下为在显示屏上的显示效果:



The display effect on the display screen is as follows:

Style=0时 
Style = 0 (Graph)

Style=1时 
Style = 1 (Graph)

Style=2时 
Style = 2 (Graph)

Style=4时  其中框的颜色由frame_color来指定。
Style = 4 (Graph) where the color of the frame is specified by frame _ color.

style=8时  为无底色 但style不等于8时 TEXT都是带底色的, 如 
(Graph) has no background color when style = 8, but TEXT has background color when style = 8, such as (Graph)

注意: style=8可以与上面的style=0,style=1,style=2,style=4进行组合。

Note: style = 8 can be combined with style = 0, style = 1, style = 2, style = 4 above.

注意:

Notice

1)、每一条完整的指令必须要以'\r\n'结束, 模块只有接收到'\r\n'才开始执行指令或指令串。

1) Each complete instruction must end with '\ R \ n ', and the module will not execute the instruction or instruction string until it receives ' \ R \ n '.

2)、指令与指令之间通过';'来分割, 模块能接收单条指令也能接收指令串, 指令串的最大字符数不能超过 500 个字节。

2) Instructions are separated by ';'. The module can receive a single instruction

as well as an instruction string. The maximum number of characters in an instruction string cannot exceed 500 bytes.

3)、每条指令后面都必须检查模块回馈回来的'OK\r\n' 或者通过延时等待的方式来确定已经执行完当前指令方可以发送下一条指令,如果第一条指令没有执行完马上就发送下一条指令,模块有可能因为缓冲不够而导致指令丢失的情况。

3) Each instruction must be followed by checking the 'OK \ R \ n ' returned by the module or determining that the current instruction has been executed by means of delay waiting. If the first instruction is not executed, the next instruction will be sent immediately. The module may lose instructions due to insufficient buffering.

- 指令的执行时间

- The execution time of an instruction

指令 Instruction	指令执行时间 (ms) Instruction execution time (ms)
VER;	40
CLR(1);	25
FSIMG 全图 FSIMG full map	65
DC16(0,0,'中国',1); DC16(0,0,'China',1);	30
DCV16(0,0,'中国',1); DCV16(0,0,'China',1);	30
DC24(0,0,'中国',1); DC 24(0,0,'China',1);	35
DCV24(0,0,'中国',1); DCV24(0,0,'China',1);	35
DC32(0,0,'中国',1); DC32(0,0,'China',1);	40
DCV32(0,0,'中国',1); DCV32(0,0,'China',1);	40
DC48(0,0,'中国',1,0); DC48(0,0,'China',1,0);	/
DC72(0,0,'A1',1,0);	/
BOX(0,0,100,100,1);	40
BOXF(0,0,100,100,1);	40
CIR(10,10,5,2);	25
CIRF(10,10,5,2);	30
BTN(20,80,32,16,'按钮',1,0,1,4); BTN(20,80,32,16,'button',1,0,1,4);	45
DIR(1);	20
BPS(115200);	235

BL (20) ;	15
PS (20, 20, 1) ;	20
PL (0, 0, 90, 90, 1) ;	30
BOOT_START (200) ;	25
MODE_CFG (0) ;	230

- 典型应用实例
- Typical application examples

1. 字符及图片叠加功能

Character and picture overlay function



2. 横竖屏切换功能

Horizontal and vertical screen switching function

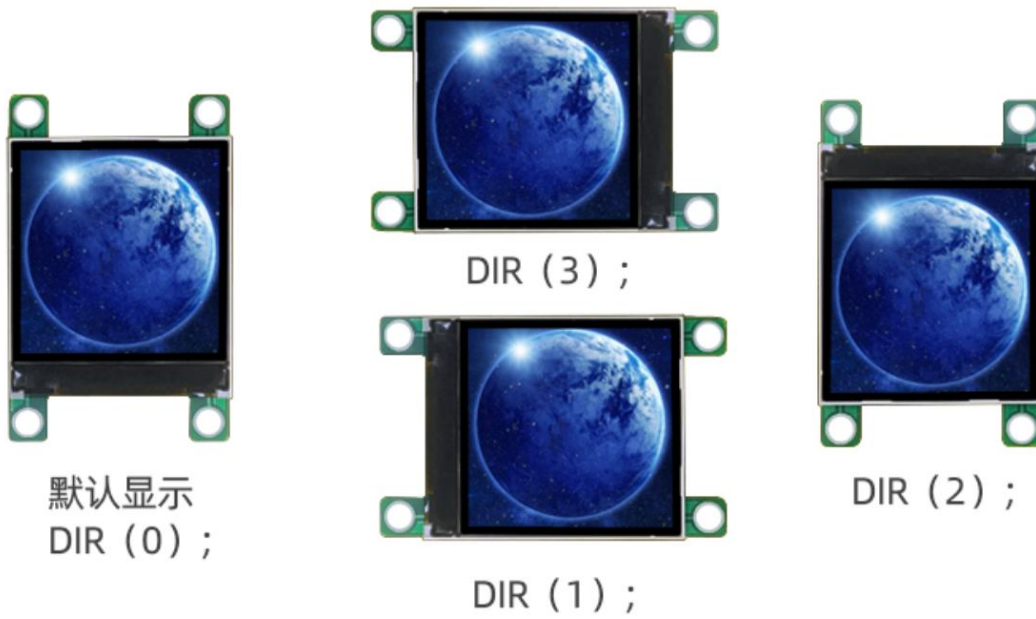

3. 图形函数功能

Graph function function

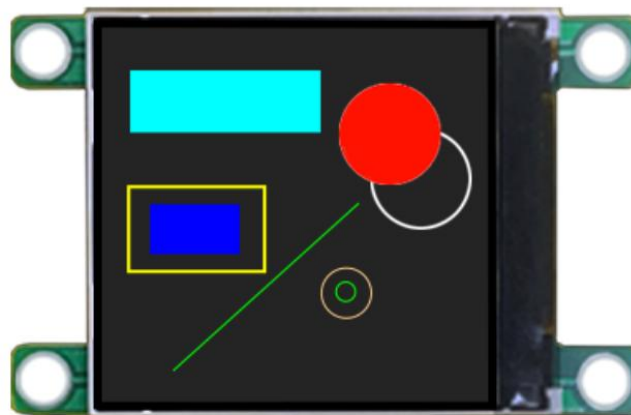

4. 背光亮度调节功能

Backlight brightness adjustment function



BL(200); —— 背光调暗



BL(0); —— 背光最亮

***BL(255);为背光关断，此时显示屏呈现黑色界面，
为给客户示例上图采用BL(200);**

5、显示代码演示

5. Display code demonstration

1)、显示字体

1) Display font

```
UartSend ("CLR(0);SBC(3);DC16(0,0,'Uart显示屏',1);DC24(0,20,'Uart显示屏',1);DC32(0,48,'Uart显示屏',1);DCV16(0,84,'Uart显示屏',1);DCV24(0,104,'Uart显示屏',1);DCV32(0,132,'Uart显示屏',1);PL(0,170,175,170,1);BOXF(110,180,170,210,1);CIR(50,195,20,1);\r\n");  
Delay_ms(100);
```



2) 、显示变化的数字

2) Display the changed number

```
double v=0.12; char buf[128]; char i; for(i=0; i<50; i++) { sprintf(buf,"CLR(15);DC48(80,180,'%3.1f',1);\r\n",v); v=v+1.2; UartSend(buf); delay_ms(10); }
```

