

2.4 寸集成串口屏(带 485 地址)

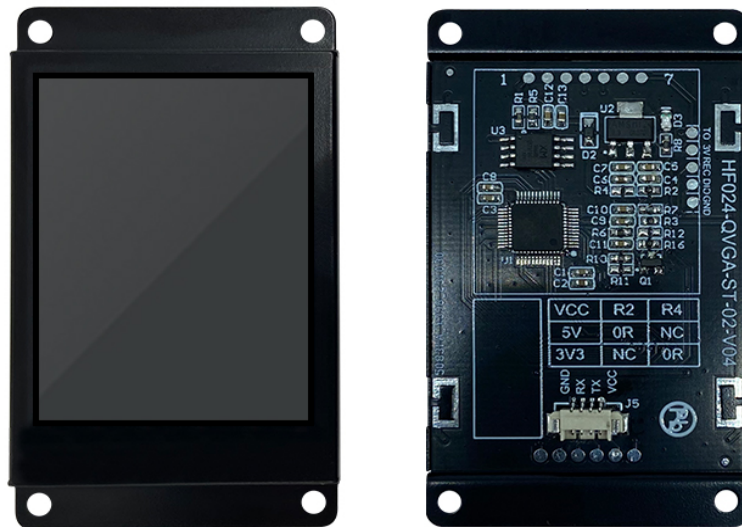

2.4 inch integrated serial port screen (with 485 address) (Graph)

*由于我司会对串口屏模块不定时更新升级，版本号会出现与旧版本不一致，此时硬件软件不会出现不一致的现象，只是升级增强了硬件软件的兼容性。

* Because our company will update and upgrade the serial port screen module irregularly, the version number will be inconsistent with the old version. At this time, the hardware and software will not be inconsistent, but the upgrade will enhance the compatibility of the hardware and software.

修订记录

Revision record

版本	发布者	修改内容	修改日期
----	-----	------	------

2.4 寸集成串口屏(带 485 地址)规格书

2.4 inch Integrated Serial Port Screen (with 485 address) Specification

Version	Publisher	Modify the content	Date of modification
A	Liangyq	初版 First edition	2022/05/07

产品概述

Product overview

2.4 寸 HF 系列串口屏（简称：HFD）的点阵分辨率是 240x320。其内置国标一级、二级简体中文字库和英文 ASCII 字符集，同时开放内部点阵 DDRAM，能够在屏幕上的任意位置显示图片及图形。硬件上它提供 UART 接口方式，接线简单。配合我司开发的 sGUI 拖拽编程工具工具，用户只要几条简单指令就能设计出美观绚丽的用户界面，从此用户不再需要花费高昂的硬件成本及漫长的开发周期来为设备仪器配置 LCD 彩屏，HFD 丰富的片上资源及强大的指令集，是客户项目开发的首选方案。

The dot matrix resolution of the 2.4-inch HF series serial screen (HFD) is 240x320. It has built-in simplified Chinese font library and English ASCII character set, and open internal dot matrix DDRAM, which can display pictures and graphics at any position on the screen. In terms of hardware, it provides UART interface mode with simple wiring. With the sGUI drag-and-drop programming tool developed by our company, users can design beautiful and gorgeous user interfaces with only a few simple instructions. From then on, users no longer need to spend high hardware costs and long development cycles to configure LCD color screens for equipment and instruments. HFD's rich on-chip resources and powerful instruction set are the preferred solution for customer project development.

- 外形尺寸
- Overall dimensions

测量类型 Type of measurement	测量数据 (±0.2) Measured data (± 0.2)
外观尺寸 Exterior dimensions	47. 62mm*77. 41mm*9. 3mm

- 显示性能参数
- Displays the performance parameters

参数类型 Parameter type	测量数据 Measurement data	说明 Explain
显示区域 (A. A) Display area (A. A)	36. 72mm*48. 96mm	/
分辨率 (ppi) Resolution (PPI)	240*320	/
显示颜色	65K	/

2.4 寸集成串口屏(带 485 地址)规格书

2.4 inch Integrated Serial Port Screen (with 485 address) Specification

Display color		
像素布局 Pixel layout	RGB 垂直条状 RGB vertical strip	/
最佳视角 Best viewing angle	12:00 12:00	/
对比度 Contrast	800:1 (Typ.) (透射) 800:1 (Typ.)	/
背光光源类型 Backlight light source type	WHITE LED	高亮白色 LED 灯, 调节背光亮度 Highlight white LED, adjust backlight brightness
模块亮度 Module brightness	420cd/m2	/
室内外可视 Visible indoors and outdoors	是 Yes	/
DDRAM	153K 显存 153K video memory	开放内部 DDRAM Open internal DDRAM

- 电性能参数
- Electrical performance parameters

参数类型 Parameter type	测试条件 Test conditions	最小值 Minimum value	标准值 Standard value	最大值 Maximum value	单位 Unit
工作电压范围 Operating voltage range	输入电压 (VDD: +3.3V, +5.0V 可选); 可通过背面元器件区域 (R2-5V)、(R4-3.3V) 电阻, 使用 5V 时电阻应在 R2 位, 使用 3.3V 时电阻应在 R4 位, 如模块电阻位在 R4 (3.3V), 使用 5V 电源输入会烧坏主板及相关元器件。 Input voltage (VDD: +3.3 V, +5.0 V optional); can be through the rear component area (R2-5V), (R4-3.3 V) resistance, the resistance should be at R2 when using 5V, the resistance should be at R4 when using 3.3 V, if the module resistance is at R4 (3.3 V), using 5V power input will burn out the motherboard and related components.				
		最小值 Minimum value	标准值 Standard value	最大值 Maximum value	单位 Unit
工作电流 (5V) Operating current (5V)	背光最亮 The backlight is the brightest	-	130	-	mA
	背光最暗 The backlight is the darkest	-	20	-	mA
工作电流 (3.3V) Operating Current (3.3 V)	背光最亮 The backlight is the brightest	-	100	-	mA
	背光最暗 The backlight is the darkest	-	20	-	mA
工作功耗 (5V) Power consumption (5V)		100	-	650	mW
工作功耗 (3.3V) Operating Power (3.3 V)		66	-	330	mW

- 工作环境参数
- Working environment parameters

参数类型 Parameter type	测试环境 Test environment	最小值 Minimum value	标准值 Standard value	最大值 Maximum value	单位 Unit
------------------------	--------------------------	----------------------	-----------------------	----------------------	------------

2.4 寸集成串口屏(带 485 地址)规格书

2.4 inch Integrated Serial Port Screen (with 485 address) Specification

工作温度 Operating temperature	-	-20	-	60	°C
储存温度 Storage temperature	-	-30	-	70	°C
工作湿度 Operating humidity	25°C	10%	60%	90%	RH
出厂老化 Factory aging 测试 Test	-	-	8	-	H
通讯接口 Communication interface	UART 接口 1.25mm 4Pin UART connector 1.25 mm 4 Pin				

- 接口性能参数：（9600/19200/38400/115200）
- Interface performance parameters: (9600/19200/38400/115200)

	最小值 Minimum value	标准默认值 Standard default value	最大值 Maximum value	单位 Unit
串口波特率 Serial port baud rate	9600	115200	115200	Bps
串口接收电平 (RX) Serial port receiving level (RX)	2.8V	3.3V	3.5V	V
串口接收电平 (RX) Serial port receiving level (RX)	2.8V	3.3V	3.5V	V

- 接口定义
- Interface definition

	引脚名称 Pin name	引脚电平 Pin level	功能描述 Functional description
	GND	0	电源接地端 Power supply ground terminal

2.4 寸集成串口屏(带 485 地址)规格书

2.4 inch Integrated Serial Port Screen (with 485 address) Specification

	RX	5V/3.3V	主控芯片 UART 数据接收端 Main control chip UART data receiving terminal
	TX	5V/3.3V	主控芯片 UART 数据发送端 Main control chip UART data sending terminal
	VCC	5V/3.3V	电源供电端 Power supply terminal

注意：如果VCC是3.3V输入时，需要将背面的电阻R4短路、R2开路。模块出厂默认的为5.0V供电输入!!!
Note that if VCC is a 3.3 V input, the resistor R4 on the back needs to be shorted and R2 opened. The module's factory default is 5.0 V supply input!!!

- 硬件接口示意图
- Hardware interface diagram

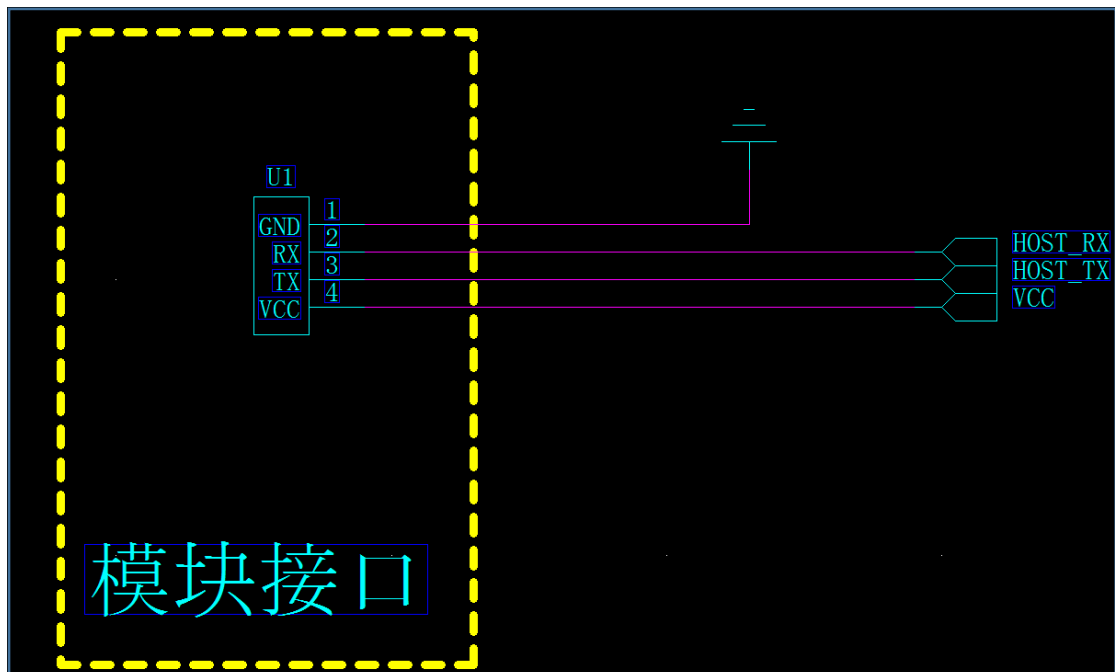

- 电源上电时序
- Power supply power-up sequence

电源给模块供电时，必须保证电压在 80ms 之内稳定在 5V/ 3.3V, 如果不满足这个条件，模块有可能会概率性显示不正常的情况。

When the power supply supplies power to the module, the voltage must be stabilized at 5V/3.3V within 80ms. If this condition is not met, the module may have abnormal probability display.

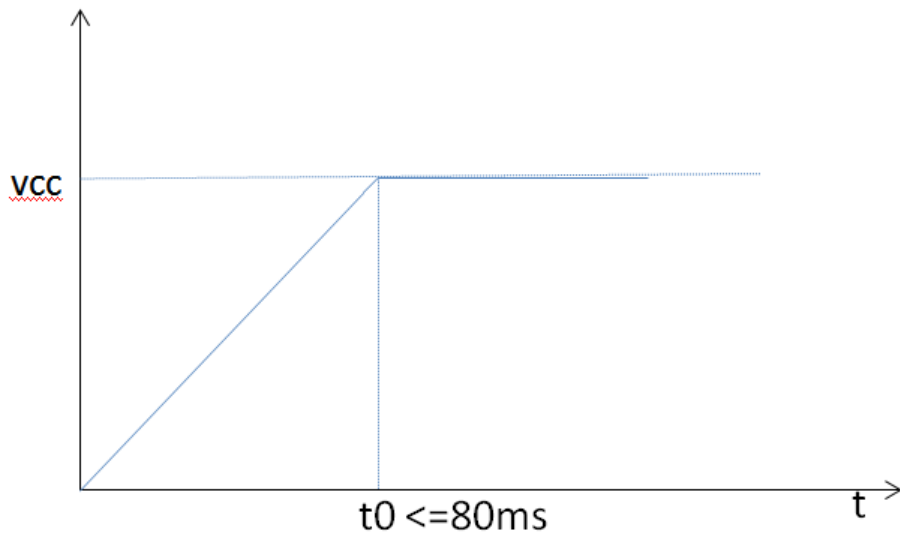

- 软件上电流程
- Software power-on process

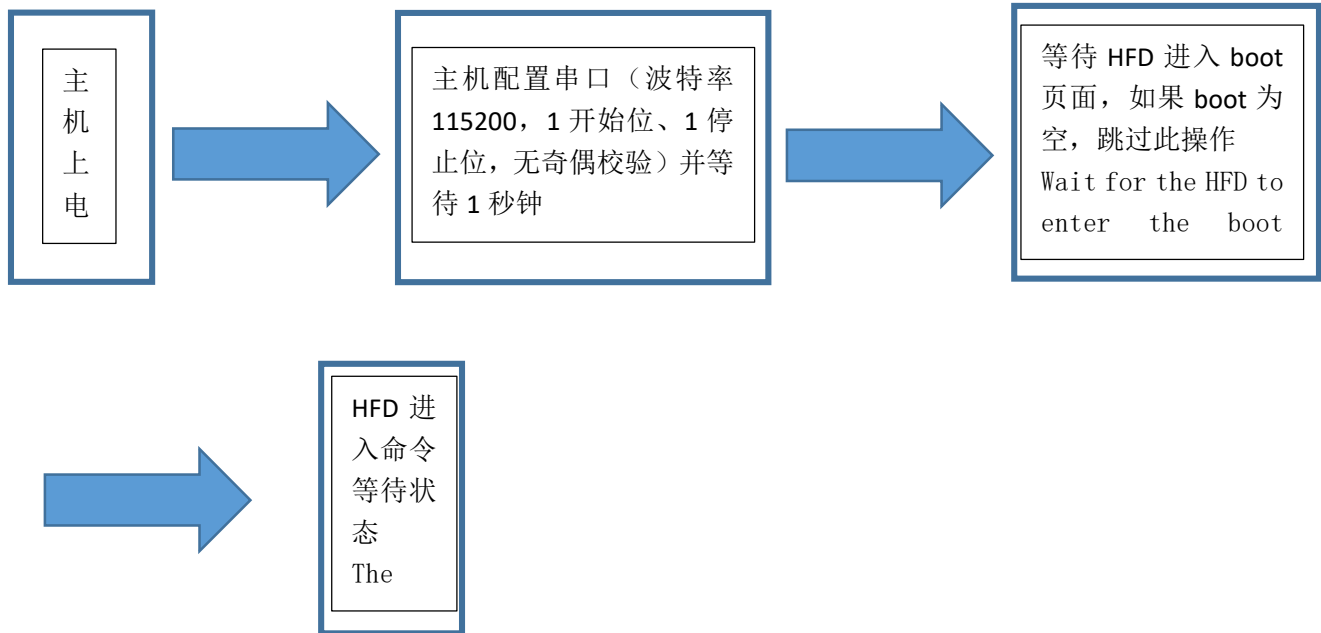

注意：上电等待 1 秒以上是模块正常工作的前提，如果没有足够的等待时间模块有可能无法正常接收指令而导致系统出错。

Note: Waiting for more than 1 second after power on is the prerequisite for normal operation of the module. If there is not enough waiting time, the module may not be able to receive instructions normally, resulting in system errors.

- 存储器特性
- Memory characteristics

存储器类别 Memory class	参数类别 Parameter category	最小值 Minimum value	标准值 Standard value	最大值 Maximum value	单位 Unit
FLASH	字库储存空间 Font storage space	-	5	-	MB
	图片储存空间 Picture storage space	-	3	-	MB
	全屏图片储存数量 Number of full-screen images saved	0	-	20	张/幅 Sheet/width
	图片可用储存算	裸数据存儲			

2.4 寸集成串口屏(带 485 地址)规格书

2.4 inch Integrated Serial Port Screen (with 485 address) Specification

	法 Picture available storage algorithm	Raw data storage
--	---	------------------

- 内置字库参数
- Built-in font parameters

字体类型 Font type	内置字号参数 Built-in font size parameter
中文字体 Chinese font	8192 个 GB2312 16*16 24*24 32*32 48*48 中文字体 8192 GB2312 16 * 16 24 * 24 32 * 32 48 * 48 Chinese fonts
英文字体 English font	ASCII 英文字体 8*16 16*24 16*32 24*48 36*72 48*96 ASCII English font 8 * 16 16 * 24 16 * 32 24 * 48 36 * 72 48 * 96

- 支持软件
- Support Software

类型 Type	功能描述 Functional description	使用方式 How to use
sGUI.exe	界面 UI 生成和编辑、图片下载 Interface UI generation and editing, picture download	参考：HFD 指令集、HFD 应用文档、sGUI 软件使用说明 Reference: HFD instruction set, HFD application document, sGUI software instruction

- 内置功能
- Built-in features

功能类型 Function type	支持 Support	不支持 Not supported	功能类型 Function type	支持 Support	不支持 Not supported
中文字库 Chinese font library	√		超宽视角 Super wide viewing angle	√	
英文字库 English font library	√		图像功能 Image function	√	
横竖屏选择 Horizontal and vertical screen selection	√		真彩显示 True color display	√	
画图功能 Drawing function	√		背光调节 Backlight adjustment	√	
控件功能 Control	√		开机 LOGO Boot LOGO	√	

2.4 寸集成串口屏(带 485 地址)规格书

2.4 inch Integrated Serial Port Screen (with 485 address) Specification

functionality					
二维码显示 Two-dimensional code display	√		开机动画 Boot animation	√	
485 地址 485 address	√				

- 可靠性测试
- Reliability testing

序号 Serial number	可靠性内容 Reliability content	数量 Quantity	测试条件 Test conditions	判断标准 Criteria for judgment
1	高温高湿性能 High temperature and high humidity performance	5	温度 70°C、湿度 85% 的环境中放置240H, 在 常温常湿环境下放置2H 后测定 It shall be placed for 240h in an environment with a temperature of 70 °C and a humidity of 85%, and measured after being placed for 2h in a normal temperature and humidity environment	外观无开裂、无结露、 变色、腐蚀、明显变形； 功能无缺笔、缺画，输 入电流无异常。 The appearance shall be free of cracking, condensation, discoloration, corrosion and obvious deformation; There is no missing pen or picture in the function, and the input current is normal.
2	高温性能 High temperature performance	5	温度70°C的环境中放置 240H, 取出后 Place for 240H in an environment with a temperature of 70 °C, and then take out 在常温常湿环境下放置2H 后测定 Determine after being placed for 2 H in normal temperature and humidity environment	外观无开裂、无结露、 变色、腐蚀、明显变形； 功能无缺笔、缺画，输 入电流无异常。 The appearance shall be free of cracking, condensation, discoloration, corrosion and obvious deformation; There is no missing pen or picture in the function, and the input current is normal.

2.4 寸集成串口屏(带 485 地址)规格书

2.4 inch Integrated Serial Port Screen (with 485 address) Specification

3	<p>低温性能</p> <p>Low temperature performance</p>	5	<p>温度-30℃的环境中放置 240H, 取出后 Place for 240H at -30 °C, and take out 在常温常湿环境下放置 2H后测定 Determine after being placed for 2 H in normal temperature and humidity environment</p>	<p>外观无开裂、无结露、变色、腐蚀、明显变形；功能无缺笔、缺画，输入电流无异常。 The appearance shall be free of cracking, condensation, discoloration, corrosion and obvious deformation; There is no missing pen or picture in the function, and the input current is normal.</p>
4	<p>冷热冲击实验</p> <p>Cold and hot shock test</p>	5	<p>调节试验槽温度做冷热冲击测试：70℃（30分钟）→温度下降到-20℃（5分钟）→-30℃（30分钟）→温度上升到70℃（5分钟）至此温度时间变化为一个循环（如下图）。累计测试 100 个循环，试验结束后取出，在常温常湿环境下放置 2H后测试。 Adjust the temperature of the test tank for cold and hot shock test: 70 °C (30 minutes) → the temperature drops to -20 °C (5 minutes) → -30 °C (30 minutes) → the temperature rises to 70 °C (5 minutes), and the time change of the temperature is a cycle (as shown in the figure below). Test for 100 cycles in total, take out after the test, and test after being placed for 2 H in a normal temperature and humidity environment.</p>	<p>外观无开裂、无结露、变色、腐蚀、明显变形；功能无缺笔、缺画，输入电流无异常。 The appearance shall be free of cracking, condensation, discoloration, corrosion and obvious deformation; There is no missing pen or picture in the function, and the input current is normal.</p>

2.4 寸集成串口屏(带 485 地址)规格书

2.4 inch Integrated Serial Port Screen (with 485 address) Specification

5	ESD 测试 ESD test	5	空气放电 +/-8KV Air discharge +/-8KV 接触放电 +/-4KV Contact discharge +/-4KV 方法：四边及中心位置 10 次/点 Method: 10 times/point at four sides and central position	功能无缺笔、缺画，输入电流无异常。 There is no missing pen or picture in the function, and the input current is normal.
---	--------------------	---	---	---

- 结构图纸
- Structural drawings

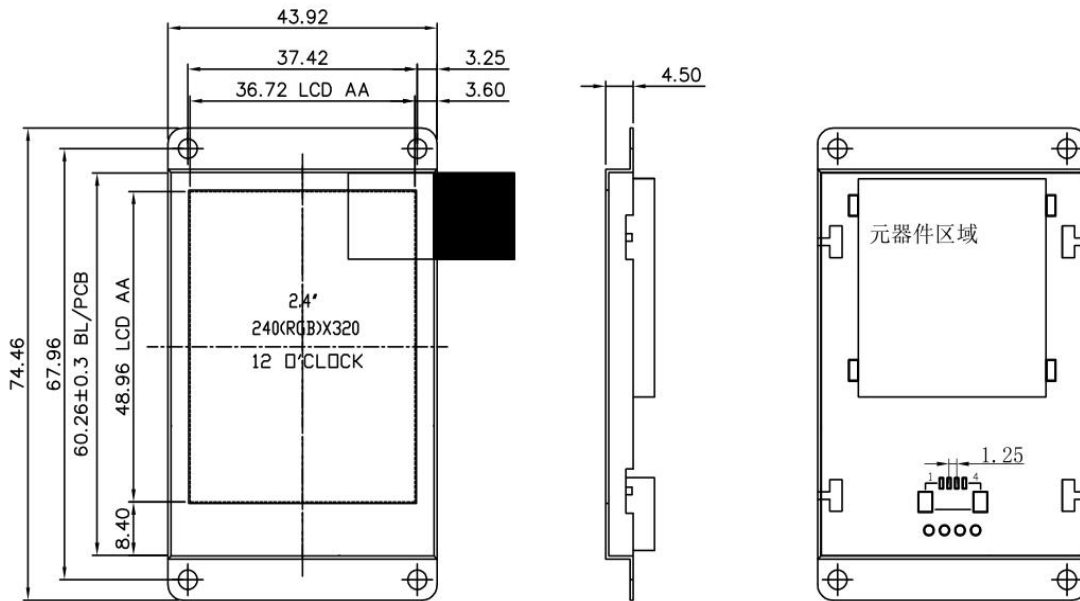

- 指令列表
- List of instructions

指令名称 Instruction name	指令说明 Instruction description	示例代码 Sample code	备注 Remark
获取版本信息 Get version info	指令 Instruction VER();	查询方式 (推荐) Query method (recommended) UartSend("VER);\r\n"); CheckBusy();	CheckBusy()的实现查看工程代码 CheckBusy() Implementation View Engineering Code Time>70(ms)
使用说明	获取模块固化的版本信息, 并显示在屏幕上	延时方式 (不推荐) Delay mode (not recommended) UartSend("VER);\r\n"); Delaysms(time);	

2.4 inch Integrated Serial Port Screen (with 485 address) Specification

<i>tion</i>	Instru ctions for use	Obtain the fixed version information of the module and display it on the screen	Delay mode (not recom mende d)		
设置 背光 亮度 Set the back light brightness	指令 Instru ction	BL(n);	查询方式 (推荐) Query method (recom mende d)	UartSend("BL(0);\r\n"); CheckBusy();	注意, 背光的亮度值 0 为 最亮, 255 为最暗 Note that the brightness value of the backlight is 0 for the brightest and 255 for the darkest Time>30(ms)
	使用说明 Instru ctions for use	BL 为指令码, n 为背光的亮度 参数其取值范围为 0~255。如果要把背光亮度 设置为 0, 则 BL(0); BL is an instruction code, n is a brightness parameter of the backlight, and the value range is 0 to 255. If the backlight brightness is to be set to 0, BL (0);	延时方式 (不 推荐) Delay mode (not recom mende d)	UartSend("BL(0);\r\n"); Delaysms(time);	
跳 转到 页面 Jump to the page	指令 Instru ction	JUMP(n);	查询方式 (推荐) Query method (recom mende d)	UartSend("JUMP(0);\r\n"); CheckBusy();	最多支持 16 个页面 Up to 16 pages are supported Time>800(ms)
	使用说明 Instru ctions for use	n 为页面 id, 其取值范围为: 0~15。 N is the page ID, and its value range is: 0 ~ 15.	延时方式 (不 推荐) Delay mode (not recom mende d)	UartSend("JUMP(0);\r\n"); Delaysms(time);	
开 关 Switch LCD	指令 Instru ction	LCDON(on_off);	查询方式 (推荐) Query method (recom mende d)	UartSend("LCDON(0);\r\n"); CheckBusy();	关闭 lcd 后屏幕的背光也 会灭掉 When the LCD is turned off, the backlight of the screen will also go out Time>200(ms)
	使用说明	on_off 为 0 或者 1, 0 关闭	延时方式 (不 推荐)	UartSend("LCDON(0);\r\n"); Delaysms(time);	

2.4 寸集成串口屏(带 485 地址)规格书

2.4 inch Integrated Serial Port Screen (with 485 address) Specification

	Instru ctions for use	lcd, 1 为开启 lcd The on_off is 0 or the 1,0 turns off the LCD, and 1 turns on the LCD	Delay mode (not recom mende d)		
更新二维码 <i>Update the QR code</i>	指令 Instru ction	QBAR(id,str);	查询方式 (推荐) Query method (recom mende d)	UartSend("QBAR(0,https://www.baidu.com);\r\n"); CheckBusy();	Time>520(ms) (二维码大小固定为 53、106、159、212) (QR code size is fixed at 53, 106, 159, 212)
	使用说明 Instru ctions for use	第一个参数为二维码的 id, 取值范围为 0~1, 第二个 参数为要显示的二维码的字符串 The first parameter is the ID of the QR code, and the value range is 0 ~ 1. The second parameter is the string of the QR code to be displayed	延时方式 (不推荐) Delay mode (not recom mende d)	UartSend("QBAR(0,https://www.baidu.com);\r\n"); Delaysms(time);	
设置数字值 <i>Set the numeric value</i>	指令 Instru ction	SET_NUM(id,val,bit);	查询方式 (推荐) Query method (recom mende d)	UartSend("SET_NUM(3,20,3);\r\n"); CheckBusy();	Time>100(ms)
	使用说明 Instru ctions for use	id 为当前页面下的数字控 件的 id, val 为要修改成的 数字, bit 为需要格式化的 位数 The ID is the ID of the numeric control under the current page, Val is the number to be modified, and bit is the number of digits to be formatted	延时方式 (不推荐) Delay mode (not recom mende d)	UartSend("SET_NUM(3,20,3);\r\n"); Delaysms(time);	
改变按钮状态 <i>Change</i>	指令 Instru ction	SET_BTN(id,status);	查询方式 (推荐) Query method (recom	UartSend("SET_BTN(0,1);\r\n"); CheckBusy();	Time>80(ms)

2.4 inch Integrated Serial Port Screen (with 485 address) Specification

nge the state of the button			mended)		
	使用说明 Instructions for use	id 为当前页面下的按钮控件的 id, status 的取值为 0 或者 1, 1 为按下状态, 0 为抬起状态 The ID is the ID of the button control on the current page, the value of the status is 0 or the 1,1 is pressed, and 0 is lifted	延时方式 (不推荐) Delay mode (not recommended)	UartSend("SET_BTN(0,1);\r\n"); Delaysms(time);	
改变 指针 值 Change the pointer value	指令 Instruction	SET_POINT(id,val);	查询方式 (推荐) Query method (recommended)	UartSend("SET_POINT(0,90);\r\n"); CheckBusy();	Time>100(ms)
	使用说明 Instructions for use	id 为当前页面下的指针控件的 id, val 的取值范围为: 0~360° The ID is the ID of the pointer control under the current page, and the value range of Val is 0 ~ 360 °.	延时方式 (不推荐) Delay mode (not recommended)	UartSend("SET_POINT(0,90);\r\n"); Delaysms(time);	
设置 进度 值 Set the progress value	指令 Instruction	SET_PROG(id,val);	查询方式 (推荐) Query method (recommended)	UartSend("SET_PROG(0,90);\r\n"); CheckBusy();	Time>110(ms)
	使用说明 Instructions for use	id 为当前页面下的进度条控件的 id, val 的取值范围为: 0~100 ID is the ID of the progress bar control under the current page, and the value range of Val is: 0 ~ 100	延时方式 (不推荐) Delay mode (not recommended)	UartSend("SET_PROG(0,90);\r\n"); Delaysms(time);	
修改 文本 Change text	指令 Instruction	SET_TXT(id,'txt');	查询方式 (推荐) Query	UartSend("SET_TXT(0,'系统已经关闭' \r\n); UartSend ("" SET _ TXT (0, 'System has shut down' \ R \ n); CheckBusy();	Time>130(ms)

2.4 inch Integrated Serial Port Screen (with 485 address) Specification

<i>Modify the text</i>			method (recommended)		
	使用说明 Instructions for use	id 为当前页面下的文本控件的 id, 'txt' 为要显示的字符串, 注意字符串的总字节数不能超过 32 个 ASCII. The ID is the ID of the text control under the current page, and the 'txt' is the string to be displayed. Note that the total number of bytes of the string cannot exceed 32 ASCII.	延时方式 (不推荐) Delay mode (not recommended)	UartSend("SET_TXT(0,' 系统已经关闭' \r\n); UartSend ("" SET _ TXT (0, 'System has shut down' \ R \ n); Delaysms(time);	
<i>Modify the button picture</i>	指令 Instruction	SET_BTN_IMG(id,status,pid);	查询方式 (推荐) Query method (recommended)	UartSend("SET_BTN_IMG(0,0,1);\r\n"); CheckBusy();	
	使用说明 Instructions for use	id 为当前图片按钮控件的 id, status 为按钮的状态, 0 为抬起, 1 为按下, pid 为要对应状态下要修改的图片编号 The ID is the ID of the current picture button control, the status is the state of the button, 0 is lifted, 1 is pressed, and PID is the number of the picture to be modified in the corresponding state	延时方式 (不推荐) Delay mode (not recommended)	UartSend("SET_BTN_IMG(0,0,1);\r\n"); Delaysms(time);	Time>80(ms)
<i>Reset command</i>	指令 Instruction	RESET();	查询方式 (推荐) Query method (recommended)	UartSend("RESET);\r\n"); CheckBusy();	Time>1100(ms)

2.4 inch Integrated Serial Port Screen (with 485 address) Specification

<i>and</i>	使用说明 Instructions for use	无参数, 用于重新启动模块 No arguments, used to restart the module	延时方式 (不推荐) Delay mode (not recommended)	UartSend("RESET);\r\n"); Delaysms(time);	
<i>延时指令 Delay Instruction</i>	指令 Instruction	DELAYMS(ms);	查询方式 (推荐) Query method (recommended)	UartSend("DELAYMS(100);\r\n"); CheckBusy();	
	使用说明 Instructions for use	使用说明 等待延时, 其中无 ms 为需要延时的时间, 最大不能超过 1500. Instructions for use Wait for the delay, where no ms is the time to be delayed, and the maximum time cannot exceed 1500.	延时方式 (不推荐) Delay mode (not recommended)	UartSend("DELAYMS(100);\r\n");	Time> 50(ms)
<i>设置前景色 Set Foreground Color Setting</i>	指令 Instruction	SET_FCOLOR(id,color_id);	查询方式 (推荐) Query method (recommended)	UartSend("SET_FCOLOR(0,1);\r\n"); CheckBusy();	time 的值查看产品规格 Value of time View product specification Books
	使用说明 Instructions for use	设置前景色id 为控件 id, color_id 为颜色编号, 此指令仅支持 BTN/TXT/NUM 控件. Set foreground ID as control ID and color_ID as color number. This command only supports BTN/TXT/NUM controls.	延时方式 (不推荐) Delay mode (not recommended)	UartSend("SET_FCOLOR(0,1);\r\n"); Delaysms(time);	
<i>设置背景色 Set Background Color</i>	指令 Instruction	SET_BCOLOR(id,color_id);	查询方式 (推荐) Query method (recommended)	UartSend("SET_BCOLOR(0,2);\r\n"); CheckBusy();	time 的值查看产品规格 Value of time View product specification Books

2.4 寸集成串口屏(带 485 地址)规格书

2.4 inch Integrated Serial Port Screen (with 485 address) Specification

景 色 指 令 Fin ger Ling			d)		
	使用说明 Instructions for use	设置背景色id 为控件 id, color_id 为颜色编号, 此指令仅支持 BTN/TXT/NUM 控件 Set background ID as control ID and color_ ID as color number. This command only supports BTN/TXT/NUM controls	延时方式 (不推荐) Delay mode (not recommended)	UartSend("SET_BCOLOR(0,2);\r\n"); Delays(time);	
设 置 背 景 色 2 指 令 Fin ger Ling	指令 Instruction	SET_BCOLOR2(id,color_id);	查询方式 (推荐) Query method (recommended)	UartSend("SET_BCOLOR2(0,4);\r\n"); CheckBusy();	time 的值查看产品规格 Value of time View product specification 书 Books
	使用说明 Instructions for use	设置背景色2 (按下背景色) id 为控件 id, color_id 为颜色编号, 此指令仅支持 BTN/TXT/NUM 控件 Set the background 2 (press the background color) ID as the control ID, and color_ ID as the color number. This command only supports BTN/TXT/NUM controls	延时方式 (不推荐) Delay mode (not recommended)	UartSend("SET_BCOLOR2(0,4);\r\n"); Delays(time);	
设 置 边 框 颜 色 指 令 Fin ger Ling	指令 Instruction	SET_FRAME_COLOR(id,color_id);	查询方式 (推荐) Query method (recommended)	UartSend("SET_FRAME_COLOR(0,1);\r\n"); CheckBusy();	time 的值查看产品规格 Value of time View product specification 书 Books
	使用说明 Instructions for use	设置边框颜色 id 为控件 id, color_id 为颜色编号, 此指令仅支持 BTN/TXT/NUM 控件 Set border color ID as control ID and color_ ID as color number. This command only supports	延时方式 (不推荐) Delay mode (not recommended)	UartSend("SET_FRAME_COLOR(0,1);\r\n"); Delays(time);	

		BTN/TXT/NUM controls			
获取模块 485 地址 Get module 485 address	指令 Instruction	GET_ADDR();	查询方式 (推荐) Query method (recommended)	UartSend("GET_ADDR();\r\n"); CheckBusy();	time 的值查看产品规格 Value of time View product specification 书 Books
	使用说明 Instructions for use	获取模块 485 地址 Get module 485 address	延时方式 (不推荐) Delay mode (not recommended)	UartSend("GET_ADDR();\r\n"); Delaysms(time);	
设置要操作的 485 地址 Set the 485 address to be operated	指令 Instruction	ADDR(n);	查询方式 (推荐) Query method (recommended)	UartSend("ADDR(1);\r\n"); CheckBusy();	time 的值查看产品规格 Value of time View product specification 书 Books
	使用说明 Instructions for use	设置要操作的 485 地址, 其中 n 为用户给模块设定的 485 地址, 485 的地址为 1~255, 0 为广播地址 Set the 485 address to be operated, where n is the 485 address set for the module by the user, and the 485 address is 1 ~ the 255,0 is the broadcast address	延时方式 (不推荐) Delay mode (not recommended)	UartSend("ADDR(1);\r\n"); Delaysms(time);	

注意:**Notice**

- 此款屏在操作指令前, 必须先设置要操作的 485 地址, 若要广播, 485 地址则设为 0, 例如: ADDR(0);
1. For this screen, the 485 address to be operated must be set before operating the command. To broadcast, the 485 address is set to 0, for example, ADDR (0);
- 可通过 GET_ADDR 指令获取模块 485 地址, 例如: GET_ADDR();
2. The module 485 address can be obtained through the GET _ ADDR command, for example,

GET_ADDR ();

3、如果要同时操作串多个 485 模块，发送指令后则使用延时方式。

3. If you want to operate multiple 485 modules at the same time, you need to use the delay mode after sending the command.

4、可通过获取版本号指令识别模块是否带 485 地址：VER();

4. Whether the module has a 485 address can be identified by obtaining the version number instruction: VER ();

5、模块 485 地址可以通过 sGUI 上位机来设置。如下图所示：

5. The module 485 address can be set by the sGUI upper computer. As shown in the following figure:



● 颜色列表 (c 从 0~63)

● Color list (C from 0 to 63)

0	1	2	3	4	5	6	7
8	9	10	11	12	13	14	15
16	17	18	19	20	21	22	23
24	25	26	27	28	29	30	31
32	33	34	35	36	37	38	39
40	41	42	43	44	45	46	47
48	49	50	51	52	53	54	55
56	57	58	59	60	61	62	63

注意：

Notice

1)、每一条完整的指令必须要以'\r\n'结束，模块只有接收到'\r\n'才开始执行指令或指令串。

1) Each complete instruction must end with '\R \ n', and the module will not execute the instruction or instruction string until it receives ' \ R \ n '.

2)、指令与指令之间通过';'来分割, 模块能接收单条指令也能接收指令串, 指令串的最大字符数不能超过 895 个字节。

2) Instructions are separated by ';'. The module can receive a single instruction as well as an instruction string. The maximum number of characters in an instruction string cannot exceed 895 bytes.

3)、每条指令后面都必须检查模块回馈回来的'OK\r\n' 或者通过延时等待的方式来确定已经执行完当前指令方可以发送下一条指令, 如果第一条指令没有执行完马上就发送下一条指令, 模块有可能因为缓冲不够而导致指令丢失的情况。

3) Each instruction must be followed by checking the 'OK \ R \ n ' returned by the module or determining that the current instruction has been executed by means of delay waiting. If the first instruction is not executed, the next instruction will be sent immediately. The module may lose instructions due to insufficient buffering.

- 指令的执行时间

- The execution time of an instruction

指令 Instruction	指令执行参考时间 (ms) Command execution reference time (ms)
VER;	<=70
BL (0) ;	<=30
JUMP (1) ;	<=800
LCDON (0) ;	<=200
SET_NUM (3, 20, 3) ;	<=100
SET_BTN (0, 1) ;	<=80
SET_POINT (0, 90) ;	<=100
SET_PROG (0, 90) ;	<=110
SET_TXT (0, '系统已经关闭') ; SET _ TXT (0, 'System has been shut down');	<=130
QBAR (id, 这位置最多输入 180 个字节 数) ; QBAR (ID, input 180 bytes at most in this position);	<=520
RESET () ;	<=1100

- 典型应用实例

- Typical application examples

1. 字符及图片叠加功能

Character and picture overlay function



2. 图形函数功能

Graph function function

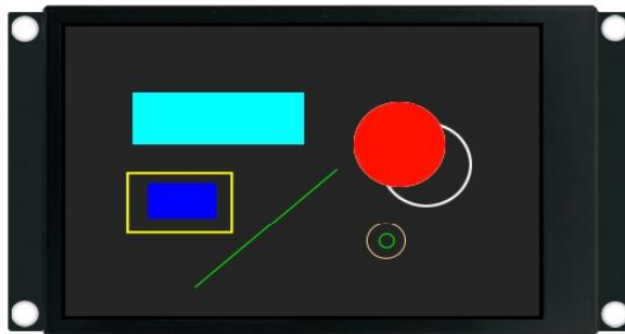

3. 背光亮度调节功能

Backlight brightness adjustment function

2.4 寸集成串口屏(带 485 地址)规格书

2.4 inch Integrated Serial Port Screen (with 485 address) Specification



4. 二维码和进度条

QR code and progress bar



5. 模块显示方向

The module displays the orientation

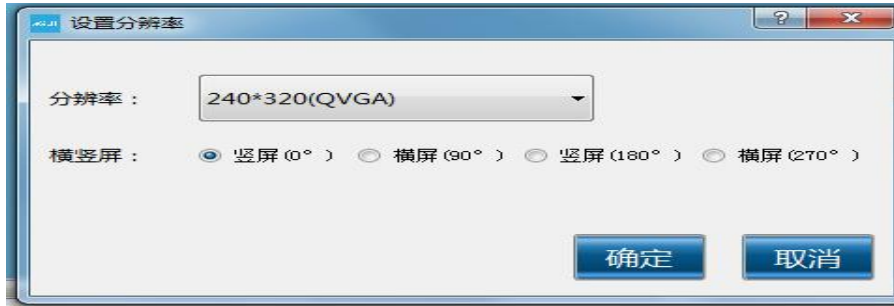

横屏 (270°)



竖屏 (0°)



竖屏 (180°)



横屏 (90°)